



**2025 PRODUCT  
CATALOG**





Based in the largest multi-sector business hub in Latin America, ELG is a Brazilian national leader in technology and innovation. Our mission is to simplify, connect, and enhance people's daily lives by delivering products of uncompromising quality.

# MORE TECHNOLOGY, MORE INNOVATION, MORE ELG.

---

**OVER 35.000**  
POINTS OF SALE

**400+**  
PRODUCTS













**20+**  
CERTIFICATIONS



With 22 years of history, the ELG Group has remained steadfast in its commitment to quality and technological innovation. The expertise and insights gained along this journey have secured our market position and earned us customer recognition and admiration.

The dedication of our team, clients, and partners—who contribute daily to strengthening our business—remains the driving force behind our success.

We are committed to forging the path ahead, developing cutting-edge technologies and creating smart solutions to meet the needs of diverse audiences and demands.

<b>SMART HOMES</b> 	Comfort..... 11
	Lighting..... 15
	Safety..... 17
	Monitoring..... 19
<b>WALL MOUNTS</b> 	For Monitors..... 25
	Fixed TV Wall Mounts ..... 33
	Full Motion TV Wall Mounts..... 37
	Tiltable for TVs..... 41
	Video Wall and TV Pedestals ..... 43
	Projectors and TV Ceiling Mounts ..... 47
	Multifunctional Oven Wall Mounts ..... 49
	Receiver Converter Wall Mounts..... 51
<b>DIGITAL ANTENNAS</b> 	External..... 55
	Internal ..... 57
<b>AUDIO AND VIDEO CABLES</b> 	HDMI ..... 59
	DisplayPort and Optical ..... 61
	P2 ..... 62
<b>SMARTPHONE ACCESSORIES</b> 	Cables..... 65
	Wall Chargers ..... 73
	Charger Kits ..... 77
	Induction Chargers..... 79
	Vehicle Chargers ..... 81
	Car Phone Holders ..... 83
	Power Bank Chargers..... 85
<b>HEADPHONES</b> 	Headsets and In-ear Wired Headphones..... 87
<b>HUB ADAPTERS</b> 	HUBs ..... 91
<b>ALLOCACOC LINE</b> 	Power Cubes..... 95
<b>OFFICE LINE</b> 	Mousepads..... 99
	Chairs..... 101
<b>GAMING</b> 	Chairs..... 107
	Headphones ..... 113
	Keyboards..... 117
	Mouse ..... 119
	Mousepads..... 121
	Kits..... 123
<b>CHECKOUT SOLUTIONS</b> 	Express Line..... 127
<b>POS DISPLAYS</b> 	POS Displays..... 133



Award-Winning  
Design Excellence



Longest Battery Life  
in the market



NEW RELEASE

2 YEARS  
WARRANTY

Security, convenience, and innovation in one. The award-winning design blends aesthetics and technology for greater comfort and practicality. Keep your spaces safer with the new ELG Smart Lock.



Up to 18-Month  
Battery Life



IP54 Protection  
Rating



Supports Up to  
50 User Profiles



2 Unlocking  
Modes



Auto-Locking  
System



Completely  
Wireless

# Smart Lock



**SCFD100PR**  
Smart Lock  
Black



**SCFD100CZ**  
Smart Lock  
Grey



- Audio setup assistant in Portuguese and English
- Compatible with doors 30-50mm thick
- Wire-free installation (requires 4 AA batteries)
- LED indicator for operation status
- Smart backlit keyboard with ON/OFF function
- Works with all opening directions and positions
- Visual and audible low-battery alerts
- Fake PIN code feature for extra security
- USB-C port for emergency power
- Easy installation with template and complete kit included



# SMART HOMES

Transform your home into a smart haven with ELG Connect. Elevate your spaces with cutting-edge comfort, lighting, security, and monitoring solutions. Control, customize, and stay connected anytime, anywhere—all in real time, right from your smartphone.





COMFORT  
LIGHTING

MONITORING  
SAFETY

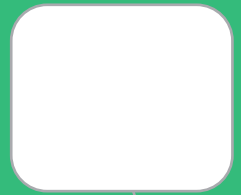



# EVERYTHING ON ONE SCREEN.

No extra devices needed. With the ELG Connect app, you can create routines, customize smart scenes, manage and monitor your cameras, locks, and all your ELG Connect devices.

Your home, right in the palm of your hand!

# ELG CONNECT APP INSIDE OUT.

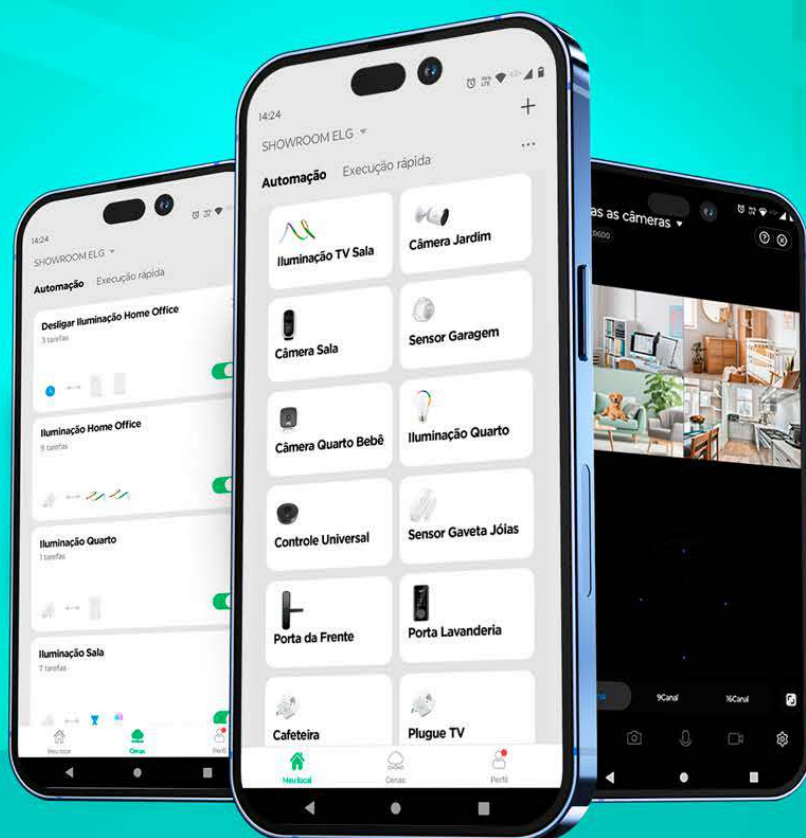

#### MULTI-USER SUPPORT.

SHARE WITH ALL YOUR FAMILY'S DEVICES.



#### REMOTE VIEWING AND CONTROL.

ACCESS FROM ANYWHERE, BY ANYONE, ANYTIME.



**MULTIPLE SCENES.** RUN YOUR SCENES WITH JUST ONE TOUCH.



WORKS SEAMLESSLY WITH ALL MAJOR **VOICE ASSISTANTS.**



**EASY SETUP.** CONNECT DIRECTLY VIA 2.4 GHZ WI-FI.



**SCHEDULING AND TIMERS.** SIMPLE SETUP AND CONFIGURATION.

DOWNLOAD IT ON THE PLATFORM OF YOUR CHOICE



Available on  
**Google Play**



Available on  
**App Store**





## SMART HOMES **CONFORT**

Technology that optimizes your time



Simplified installation  
does not require HUB



1-year  
warranty



Anatel  
Certification



Fire  
protection

Intelligent platform,  
your devices in  
one place



Remote activation  
and configuration



Multiple scenes,  
simplified connection  
with other devices



## SHFB700 BLACK SHFB700CZ WHITE Wi-Fi Smart Biometric Lock

- Lock developed for using in any direction and opening position
- Up to 300 registered users
- Backlit Smart Keyboard
- Anti-intrusion system (vandalism)
- Micro USB emergency power input



5 opening modes (biometrics, physical password, RFID card, APP and physical key)



Compatible with doors with a thickness of 30-140mm (largest range available on the market)



Anatomically designed biometric reader (30° angle)



## SHFD701 Wi-Fi Smart Digital Lock

- Lock developed for using in any direction and opening position
- Up to 200 registered users
- Smart backlit keyboard ON/OFF
- Anti-intrusion system (vandalism)
- USB-C emergency power input



4 opening modes (physical password, RFID card, APP and physical key)



Compatible with doors with a thickness of 30-50mm



Programmable automatic locking

# THE GATEWAY TO A **SMART HOME**

SHFB700

Everyone knows: security is key. Your front door is the first line of defense for your home or business, and the right lock makes all the difference for you and your family. Secure, durable, and reliable, ELG smart locks make your everyday life more efficient, offering convenience and sleek design.

## **MORE SECURITY**

- No voice assistant compatibility.
- Advanced locking system: exclusive access for admins. Blocks user access even with credentials.
- Military-grade data protection.
- End-to-end encryption.
- Panic, fake, and temporary passwords.
- Access history.
- "Do Not Disturb" lock mode.

## **MORE COMFORT**

- No HUB required—direct connection. No need for additional devices or apps.
- Stable Wi-Fi connection.
- Remote activation.
- Setup assistant with audio in Portuguese.
- Easy installation: includes template and complete kit.
- AA batteries, no wires.

## **MORE DURABILITY**

- IP65 protection rating.
- 12 months battery life.
- Low battery alert.

SHFD701



Everything at your fingertips!  
**Complete management with the ELG Connect app.**

**elg**<sup>®</sup>  
SOLUÇÕES  
INTELIGENTES



Eliminates the need for remote controls by gather your home controls together in a single device

## SHIR300

### Universal Smart Wi-Fi Remote Control

- Sophisticated and compact design
- Extensive brand library updated daily
- Broad IR compatibility: TV, DVD, projector, fan, air conditioning and more
- Auto Learning (DIY) function
- Micro USB power (cable included)



Long range Wi-Fi connection (up to 45m)



Range of up to 12m (longest range on the market)



Coverage angle: 360°



## SHPT400

### 16A Smart Wi-Fi Plug

- Automatic Bivolt (110 - 220V)
- Ultra slim format
- Power button
- LED with device operation indicator
- Wi-Fi + BLE connection



Surge protection



Power consumption monitoring



10A Pin | 1600W resistance load



## SMART HOMES LIGHTING

More color and ambiance with a simple touch



Automatic Bivolt  
(110 - 220V)



Wi-Fi  
connection



Simplified installation  
does not require HUB



1-year  
warranty



Anatel  
Certification



Fire  
protection



Intelligent platform,  
your devices in  
one place



Remote activation  
and configuration



Multiple scenes,  
simplified connection  
with other devices



Multiple users



Sync with music, movies  
and games



Voice Control



Low energy consumption  
savings of up to 85%



## SHLL100

### 10W Dimmable RGB Smart Wi-Fi & Bluetooth LED Lamp

- Circadian cycle (natural wake up)
- Perfect for any environment and occasion
- 10W
- 810 lumens
- E26 and E27 Socket
- 2500% longer service life (compared to a conventional light bulb)

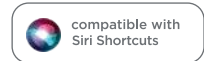

16 million RGB colors, warm and cool white



## SHFL200 3 METROS SHFL201 5 METROS

### Smart Wi-Fi Led Strip

- Adjustments in length, reversible profile
- Ideal for indoor and outdoor environments, IP65 ingress rating
- Simplified fastening: integrated 3M double-sided tape and fastening clips



16 million dimmable RGB colors

SHSM501



## SMART HOMES **SAFETY**

Enjoy the peace of a secure home



Simplified installation  
does not require HUB



1-year  
warranty



Anatel  
Certification



Complete  
mounting kit



Fire  
protection



Intelligent platform, your devices in one place



Configuration and real-time monitoring via app



Multiple scenes, simplified connection with other devices



Multiple users



Low battery alert



Scheduling and Timer



### SHSM501

#### Wi-Fi Smart Magnetic Opening Sensor

- Activation alert
- Activation history
- Long-life CR123A battery included
- Wireless. 3M adhesive fastening tape included
- Ultra-compact and discreet design



Anti-vandalism Alert



Long-range Wi-Fi connection (up to 45m)



Micro USB continuous power input (cable included)



### SHSP500

#### Wi-Fi Smart Presence Sensor

- Motion detection and alert
- Daytime and nighttime infrared surveillance technology
- Activation history
- 360 horizontal and vertical rotation
- Wireless. Fastening kit included



Longest range available on the market: 120° range of activation and distance of 10m



Double optical capture element



Long-range Wi-Fi connection (up to 45m)



## SMART HOMES MONITORING

You're in control, wherever you are



Wi-Fi  
connection



6X digital  
zoom



Full HD  
1080P



Simplified installation  
does not require HUB



1-year  
warranty



Anatel  
Certification



Fire  
protection

Intelligent platform, your devices in one place 	Configuration and real-time monitoring via app 	Multiple scenes, simplified connection with other devices 
Multiple Screens: ONVIF Protocol 	Motion detection and intensity adjustments 	Definition of monitoring area virtual fence 
Continuous or intelligent recording based on movement and area definition 	Image recording: cloud or SD card up to 128GB 	Two-way audio: talk and listen 
Night vision 	Privacy mode 	



### SHCR600

#### 1080P Wi-Fi Smart Robot Camera

- 360° view
- Onvif protocol: profile S
- Adjustable detection sensitivity
- Versatile installation: ceiling or wall installation rack
- 3.6mm lens (wide viewing angle and image detailing)
- Automatic Bivolt (110 - 220V), Micro USB power input

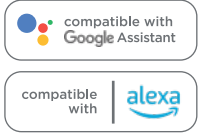

 Auto tracking (movement detection)	 Sound and motion alert	 Motorized horizontal and vertical rotation controlled by the app
---	--	--

## SHCF601 / SHCF602

### Full Color 1080P Smart Wi-Fi Outdoor Camera



- Onvif protocol: profile S
- Sound and motion detection
- Adjustable detection sensitivity
- 3.6mm lens (wide viewing angle and image detailing)
- Automatic Bivolt (110 - 220V), P2 pin power input

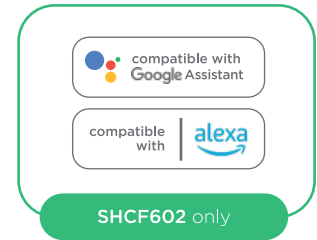



Color images even in dark settings



Direct RJ45 connection allowing device to be installed away from the router



Ideal for indoor and outdoor environments, IP65 ingress rating

## SHCI603

### 1080P Smart Wi-Fi Indoor Camera



- 2.2mm lens (wide viewing angle and image detailing)
- Decorative antenna included
- Versatile installation: ceiling or wall installation rack
- Automatic Bivolt (110 - 220V), USB-C power input



SOS button



Sound and motion detection



Adjustable detection sensitivity

# FULL COLOR VISION, EVEN IN THE DARK



The Full HD Smart Wi-Fi Outdoor Camera delivers crystal-clear images with dust and splash protection (IP65), making it perfect for both indoor and outdoor use.

**More technology, more security.**

MEET OUR FULL-COLOR CAMERA MODELS: SHCF601 | SHCF602





# WALL MOUNTS

A market leader in mounts, ELG offers a portfolio of solutions that meets all scenarios and needs. Guaranteed quality, safety, and innovation.





## WALL MOUNTS

- FOR MONITORS
- FIXED TV WALL MOUNTS
- FULL MOTION TV WALL MOUNTS
- TILTABLE FOR TVS
- VIDEO WALL AND TV PEDESTALS
- PROJECTORS AND TV CEILING MOUNTS
- MULTIFUNCTIONAL FOR OVEN RACK MOUNTS
- RECEIVER CONVERTER WALL MOUNTS





## RACK MOUNTS

# MONITOR DESK MOUNTS

Work or leisure with ergonomics  
and freedom of movement



Full motion



Optimized  
space



Gas piston  
technology



Simplified  
installation



Ergonomics  
and safety

LATEST GENERATION GAS PISTON  
TESTED WITH OVER 20,000 CYCLES



INCLUDES A COMPLETE INSTALLATION KIT FOR  
EDGE AND TABLETOP MOUNTING



SMOOTH AND PRECISE  
ADJUSTMENT

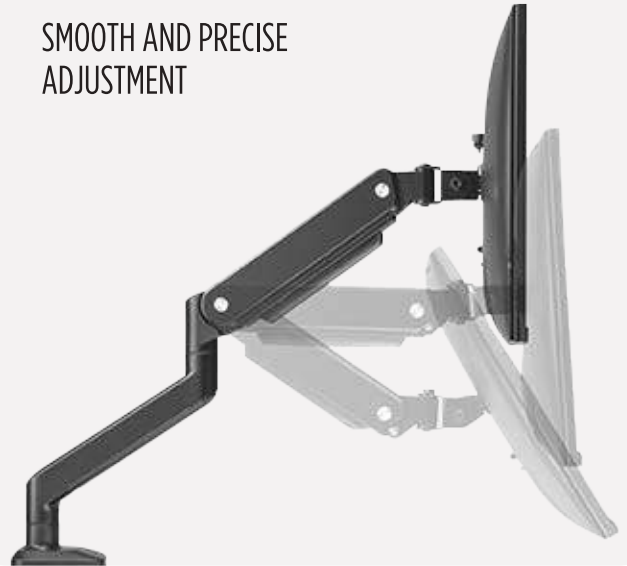

INTEGRATED CABLE  
ORGANIZER



QUICK-FIT  
FOR EASY  
INSTALLATION



FULL MOTION





## F80W

- For monitors between **17" and 35"**
- Supported weight between **2 and 9Kg**
- VESA **75x75 from 100x100mm**
- Vertical TILT between +85° and -30°
- Monitor rotation: 360°
- Base rotation up to 220°
- Height adjustment 15 to 41cm

**Fastening for top and edge of tables included**



## F80SKIN-W

NEW RELEASE

- For monitors between **17" and 35"**
- Supported weight between **2 and 9Kg**
- VESA **75x75 from 100x100mm**
- Vertical TILT between +85° and -30°
- Monitor rotation: 360°
- Base rotation up to 220°
- Height adjustment 15 to 41cm
- Customization kit

**Fastening for top and edge of tables included**



## F80N

- For monitors between **17" and 35"**
- Supported weight between **2 and 9Kg**
- VESA **75x75 from 100x100mm**
- Vertical TILT between +85° and -30°
- Monitor rotation: 360°
- Base rotation up to 220°
- Height adjustment 15 to 41cm

**Fastening for top and edge of tables included**



## F90USB

2 USB 3.0 PORTS

2 USB 3.0 CABLES - 1.5M INCLUDED

- For monitors between **17" and 35"**
- Supported weight between **2 and 9Kg**
- VESA **75x75 from 100x100mm**
- Vertical TILT between +85° and -30°
- Monitor rotation: 360°
- Base rotation up to 220°
- Height adjustment 15 to 41cm

**Fastening for top and edge of tables included**



### F160N

DESIGNED FOR USE WITH 2 MONITORS

For monitors between **17" and 35"**

Supported weight between **2 and 9Kg per monitor**

VESA **75x75 from 100x100mm**

Vertical TILT between **+85° and -30°**

Monitor rotation: **360°**

Base rotation up to **220°**

Height adjustment **15 to 41cm**

Fastening for top and edge of tables included



### F180USB

1 USB 3.0 5GB/S PORT

1 USB 3.0 1.5M CABLE INCLUDED

DESIGNED FOR USE WITH 2 MONITORS

For monitors between **17" and 35"**

Supported weight between **2 and 9Kg per monitor**

VESA **75x75 from 100x100mm**

Vertical TILT between **+85° and -30°**

Monitor rotation: **360°**

Base rotation up to **220°**

Height adjustment **15 to 41cm**

Fastening for top and edge of tables included



### FH80L

For monitors between **22" and 35"**

Supported weight between **2 and 9Kg**

VESA **75x75 from 100x100mm**

Vertical TILT between **+70° and -45°**

Monitor rotation: **360°**

Height adjustment up to **60cm**

Arm reach of up to **51,5cm**

Fastening for top and edge of tables included



### FH160L

DESIGNED FOR USE WITH 2 MONITORS

For monitors between **22" and 35"**

Supported weight between **2 and 9Kg per monitor**

VESA **75x75 from 100x100mm**

Vertical TILT between **+70° and -45°**

Monitor rotation: **360°**

Height adjustment **24 to 67,5cm**

Maximum distance between center of monitor of **90cm**

Fastening for top and edge of tables included



### F410 MONITOR WALL MOUNT

- For monitors between **17" and 35"**
- Supported weight between **2 and 9Kg**
- VESA **75x75 from 100x100mm**
- Vertical TILT between +90° and -45°
- Inclinação lateral +90° a -90°
- Monitor rotation: 360°



### F50N

- For monitors between **17" and 34"**
- Maximum supported weight of **7Kg**
- VESA **75x75 from 100x100mm**
- Vertical TILT between +10° and -10°
- Monitor rotation: 360°
- Fastening on desks up to 4cm thick
- Height adjustment up to 34cm
- Arm reach of up to 22,3cm

Fastening for top and edge of tables included



### T80N

- For monitors between **15" and 32"**
- Maximum supported weight of **8Kg**
- VESA **75x75 from 100x100mm**
- Vertical TILT between +45° and -45°
- Monitor rotation: 360°
- Height adjustment up to 44,5cm
- Protective foam base 39 x 28cm does not scratch desk











### T80N2V DESIGNED FOR USE WITH 2 MONITORS

- For monitors between **15" and 32"**
- Maximum supported weight of **8Kg per monitor**
- VESA **75x75 from 100x100mm**
- Vertical TILT between +45° and -45°
- Monitor rotation: 360°
- Height adjustment up to 89cm
- Protective foam base 39 x 28cm does not scratch desk











### T1224N PARA 2 MONITORES

-  For monitors between **17" and 32"**
-  Maximum supported weight of **8Kg per monitor**
-  VESA **75x75 from 100x100mm**
-  Vertical TILT between +45° and -45°
-  Monitor rotation: 360°
-  Articulated arms for screen position adjustment
-  Height adjustment up to 43,5cm
-  Maximum distance between centers of monitors 80cm
-  Protective foam base 39 x 28cm does not scratch desk











### T1236N DESIGNED FOR USE WITH 3 MONITORS

-  For monitors between **13" and 27"**
-  Maximum supported weight of **7Kg per monitor**
-  VESA **75x75 from 100x100mm**
-  Vertical TILT between +45° and -45°
-  Monitor rotation: 360°
-  Articulated arms for screen position adjustment
-  Height adjustment up to 43,5cm
-  Maximum distance between centers of monitors 80cm
-  Protective foam base 39 x 28cm does not scratch desk



### T160ND4 DESIGNED FOR USE WITH 4 MONITORS

-  For monitors between **15" and 27"**
-  Maximum supported weight of **8Kg per monitor**
-  VESA **75x75 from 100x100mm**
-  Vertical TILT between +45° and -45°
-  Monitor rotation: 360°
-  Articulated arms for screen position adjustment
-  Height adjustment up to 78,8cm
-  Maximum distance between centers of monitors 72,6cm
-  Protective foam base 31,6 x 43,4cm does not scratch desk

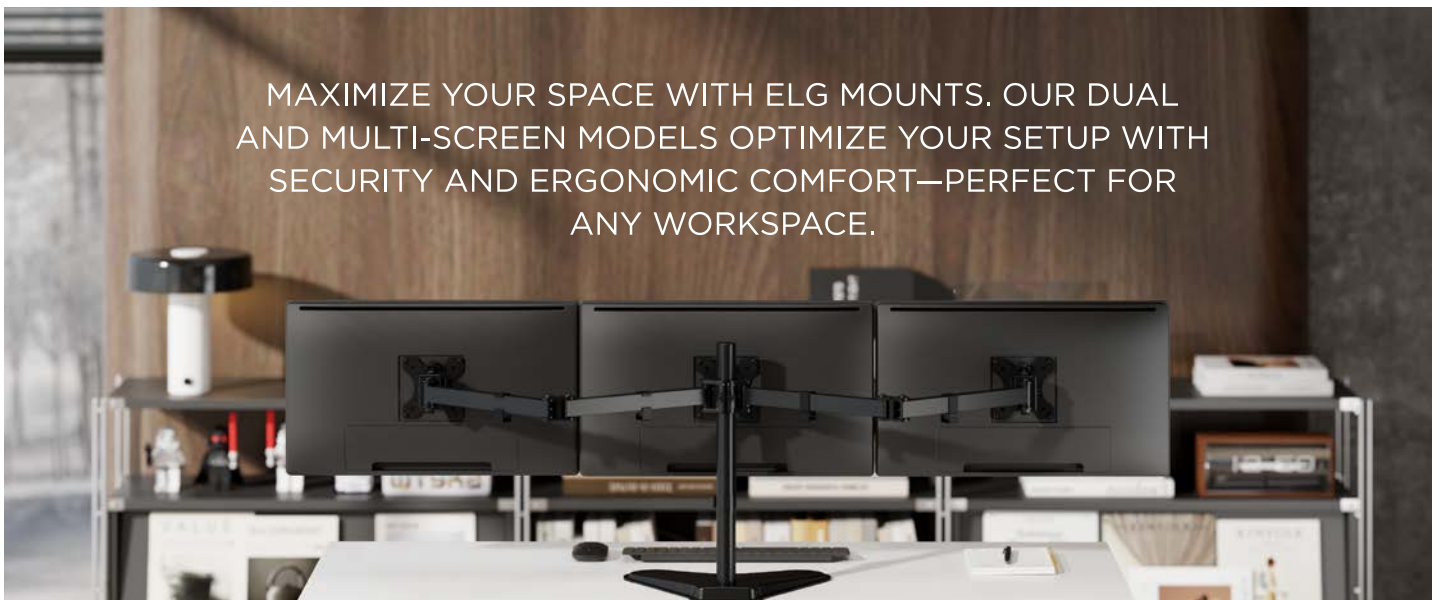

## SM087



 STEEL STRUCTURE



Maximum supported weight of **20Kg**



Attached organizer drawer



3 adjustable levels: 10, 12 and 14cm



Rubber base



Laptop air flow intake



Base: 37 x 23.5cm

## DSK01



 STEEL STRUCTURE



Maximum supported weight of **20Kg**



3 adjustable levels: 10, 12 and 14cm



Rubber base



Laptop air flow intake



Base: 37 x 23.5cm

## NTB8520W

White

## NTB8520B

Black



PORTABLE LAPTOP MOUNTS



Designed for use with laptops with screen between **10" and 17.3"**



Maximum supported weight of **14,5Kg**



Carrying bag included



10 adjustable levels



Reinforced polymer structure



Rubber laptop mounts



Rubber base



Open laptop mount:  
21.4 x 28 x 8.5-20cm



Closed laptop mount:  
6 x 28 x 1.6cm



# ORGANIZATION. ERGONOMICS. DURABILITY.

ELG: Smart solutions for every need.



PRODUCTS IN THIS IMAGE:

- SM087 RACK MOUNT
- MPEXL-LG MOUSEPAD





## WALL MOUNTS

# FIXED TV WALL MOUNTS

Clean and modern look for any setting



3-steps  
installation



Automatic  
safety lock



Bubble level  
included



Slim profile













Ultra resistant  
paint



Complete  
installation kit











## UNI100

-  Designed for use with **14" to 100"** TVs
-  Safety lock
-  Maximum supported weight of **100Kg**
-  Installation gauge included
-  VESA compatible with TVs with dimensions of **75x75mm** or greater
-  Complete installation kit
-  Anti-theft packaging
-  4 support points
-  Bubble level included
-  Distance from wall: 2,5cm









## GENIUS

-  Designed for use with **14" to 100"** TVs
-  Safety lock
-  Maximum supported weight of **100Kg**
-  Installation gauge included
-  VESA compatible with TVs with dimensions of **75x75mm** or greater
-  Complete installation kit
-  Anti-theft packaging
-  4 support points
-  Bubble level included
-  Distance from wall: 3,5cm









## FIX200

-  Designed for use with **15" to 55"** TVs
-  Automatic safety lock (Easy Lock)
-  Maximum supported weight of **45Kg**
-  Bubble level included
-  VESA **75x75 from 200x200mm**
-  Distance from wall: 2,7 ~ 3,7cm



## FIX400

-  Designed for use with **32" to 77"** TVs
-  Automatic safety lock (Easy Lock)
-  Maximum supported weight of **40Kg**
-  Bubble level included
-  VESA **100x100 from 400x400mm**
-  Distance from wall: 2,7 ~ 3,7cm



### FIX600

- Designed for use with **32" to 86"** TVs
- Maximum supported weight of **50Kg**
- VESA **100x100 from 600x400mm**
- Distance from wall: 2,7 ~ 3,7cm

- Automatic safety lock (Easy Lock)
- Bubble level include



### E200

- Designed for use with **15" to 55"** TVs
- Maximum supported weight of **30Kg**
- VESA **75x75 from 200x200mm**
- Distance from wall: 2,9 ~ 4,5cm

- Automatic safety lock (Easy Lock)
- ABS Finish
- Reinforced frame
- Bubble level include



### N01V4

- Designed for use with **32" to 77"** TVs
- Maximum supported weight of **50Kg**
- VESA **100x100 from 400x400mm**
- Distance from wall: 2,9 ~ 4,5cm

- Automatic safety lock (Easy Lock)
- Reinforced frame
- Bubble level include









### E600

- Designed for use with **32" to 86"** TVs
- Maximum supported weight of **50Kg**
- VESA **100x100 from 600x400mm**
- Distance from wall: 2,9 ~ 4,5cm
- Automatic safety lock (Easy Lock)

- Reinforced frame
- ABS Finish
- Bubble level include



## N01V8

-  Designed for use with **55" to 100"** TVs  Automatic safety lock (Easy Lock)
-  Maximum supported weight of **75Kg**  Reinforced frame
-  VESA **100x100 from 900x600mm**  Bubble level include
-  Distance from wall: 3 ~ 5cm

ELG MOUNTS ARE BUILT WITH  
REINFORCED CARBON STEEL.  
MORE STRENGTH, DURABILITY,  
AND SAFETY.

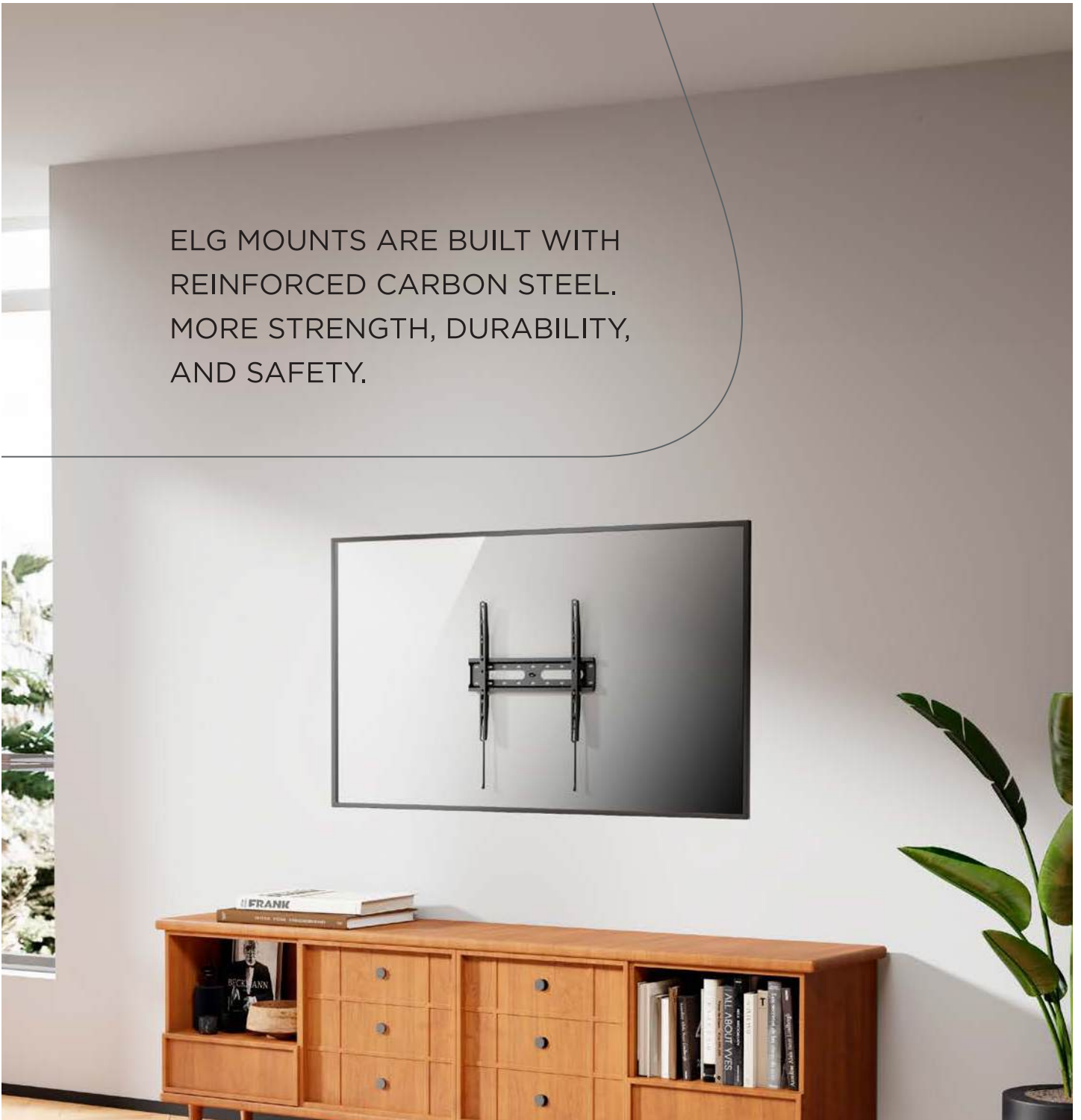



## WALL MOUNTS

# FULL MOTION TV WALL MOUNTS

Full range of motion with complete safety



Full motion



Pre-assembled with a  
3-step installation



Simplified  
cable access













Ergonomics  
and safety



Complete  
installation kit













## FULL20

-  Designed for use with TVs between **15" a 58"**
-  Maximum supported weight of **30kg**
-  VESA **75x75 from 200x200mm**
-  Vertical TILT from +20° to -5°
-  Screen level adjustment +3° to -3°
-  Swivel up to a 90° angle (left/right)
-  Distance from wall: 6 - 26cm
-  Bubble level included
-  Pre-assembled
-  3-step installation













## FULL20\_PRO

-  Designed for use with TVs between **15" a 58"**
-  Maximum supported weight of **30kg**
-  VESA **75x75 from 200x200mm**
-  Vertical TILT from +5° to -20°
-  Screen level adjustment +3° to -3°
-  Swivel up to a 90° angle (left/right)
-  Distance from wall: 6 - 40,8cm
-  Bubble level included
-  Pre-assembled
-  3-step installation













## FULL40

-  Designed for use with TVs between **26" and 65"**
-  Maximum supported weight of **30kg**
-  VESA **75x75 from 400x400mm**
-  Vertical TILT from +5° to -20°
-  Screen level adjustment +3° to -3°
-  Swivel up to a 90° angle (left/right)
-  Distance from wall: 6,5 - 26,5cm
-  Bubble level included
-  Pre-assembled
-  3-step installation











## FULL40\_PRO

-  Designed for use with TVs between **26" and 65"**
-  Maximum supported weight of **30kg**
-  VESA **75x75 from 400x400mm**
-  Vertical TILT from +5° to -20°
-  Screen level adjustment +3° to -3°
-  Swivel up to a 90° angle (left/right)
-  Distance from wall: 6,5 - 41,4cm
-  Bubble level included
-  Pre-assembled
-  3-step installation













## KF4H25

 HDMI 4K 2.0 2.5M CABLE INCLUDED

-  Designed for use with TVs between **26" and 65"**
-  Maximum supported weight of **30kg**
-  VESA **75x75 from 400x400mm**
-  Vertical TILT from +5° to -20°
-  Swivel up to a 90° angle (left/right)
-  Distance from wall: 6,5 ~ 41,4cm
-  Bubble level included
-  Pre-assembled
-  **3** 3-step installation













## A02V4N

-  Designed for use with TVs between **26" and 75"**
-  Maximum supported weight of **38kg**
-  VESA **100x100 from 400x400mm**
-  Vertical TILT from +8° to -5°
-  Screen level adjustment +4° to -4°
-  Swivel up to a 90° angle (left/right)
-  Distance from wall: 5,5 ~ 50cm
-  Bubble level included
-  Pre-assembled
-  **3** 3-step installation













## A02V6N

-  Designed for use with TVs between **32" and 86"**
-  Maximum supported weight of **46kg**
-  VESA **200x200 from 600x400mm**
-  Vertical TILT from +3° to -5°
-  Screen level adjustment +3° to -3°
-  Swivel up to a 90° angle (left/right)
-  Distance from wall: 5,2 ~ 38cm
-  Bubble level included
-  Pre-assembled
-  **3** 3-step installation



## A02V8N

-  Designed for use with TVs between **50" and 90"**
-  Maximum supported weight of **60kg**
-  VESA **300x200 from 800x400mm**
-  Vertical TILT from +3° to -15°
-  Screen level adjustment +3° to -3°
-  Swivel up to a 90° angle (left/right)
-  Distance from wall: 7,7 ~ 43cm
-  Bubble level included
-  Pre-assembled
-  **3** 3-step installation





FOR LARGE SCREENS  
**XL**

### A02V8XL



Designed for use with TVs between **55" and 90"**



Maximum supported weight of **75kg**



VESA **200x200** from **800x600mm**



Vertical TILT from +5° to -15°



Screen level adjustment +3° to -3°



Horizontal swivel up to 60° (limited to TV size)



Distance from wall: 6.9-63.5cm



Bubble level included



Pre-assembled



3-step installation



FOR GIANT SCREENS  
**XXL**

### A02V9XL



Designed for use with TVs between **60" and 120"**



Maximum supported weight of **120kg**



VESA **200x200** from **900x600mm**



Vertical TILT from +5° to -15°



Screen level adjustment +5° to -5°



Horizontal swivel up to 60° (limited to TV size)



Distance from wall: 7.5-70.3cm



Bubble level included



Pre-assembled



3-step installation

MORE  
SECURITY,  
WITH  
MOBILITY AND  
CONVENIENCE.

ELG MOUNTS  
TRUST IN  
EVERY CONNECTION.

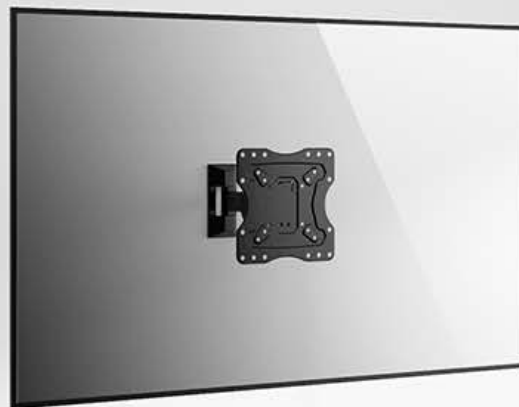



## WALL MOUNTS **TILTABLE FOR TVS**

Enjoy your screen glare-free



Pre-assembled with a  
3-step installation



Reduced  
glare



Bubble level  
included



Automatic safety lock  
(Easy Lock)



Ultra resistant  
paint



Complete  
installation kit



## A03V4S

NEW RELEASE



Designed for use with TVs between **32" and 70"**



Maximum supported weight of **45Kg**



VESA **75x75 from 400x400mm**



Vertical TILT from +0° a -10°



Vertical TILT from 2,0 - 7,0cm



Slim profile: TV closer to the wall



Bubble level included



Automatic safety lock (Easy Lock)

FOR GIANT SCREENS  
**XL**



## A03V8XL



Designed for use with TVs between **55" and 100"**



Maximum supported weight of **75Kg**



VESA **100x100 from 900x600mm**



Vertical TILT from +5° a -10°



Vertical TILT from 8,5



Bubble level included



Automatic safety lock (Easy Lock)

ELIMINATE SCREEN  
GLARE AND ENHANCE  
YOUR VIEWING ANGLE  
WITH THE TILT FEATURE.



## WALL MOUNTS

# VIDEO WALL AND TV PEDESTALS

Safe and versatile solutions for panels and large screens



Pre-assembled with a 3-step installation



Practical wall clearance system



Reinforced frame



Anti-theft latch



Practicality



Versatility



Easy to transport



Locking wheels



## LVW02-46T



Designed for use with TVs between **37" and 70"**



Maximum supported weight of **45kg**



VESA **200x200 from 600x400mm**



Distance from wall: 6,8 - 21,5cm



Pop-Out technology: access cables for maintenance purposes with just a touch of the screen



Anti-theft system (Padlock not included)



## LVW02-46F



Designed for use with TVs between **37" and 70"**



Maximum supported weight of **45kg**



VESA **200x200 from 600x400mm**



Distance from wall: 5,6 - 21,5cm









Anti-theft system (Padlock not included)

THE POP-OUT SYSTEM GIVES  
YOU QUICK AND EASY ACCESS TO  
CABLES AND CONNECTORS—NO  
HASSLE, JUST CONVENIENCE.















### A06V6\_PRO

-  Designed for use with TVs with a size greater than **32"**
-  Maximum supported weight of **65kg**
-  VESA **100x100 from 600x400mm**
-  Maximum tray support weight: **10kg**
-  TV height adjustments: 112 to 152cm
-  Locking wheels
-  Internal cable passage



### A06V6\_S

-  Designed for use with TVs between **32" and 75"**
-  Maximum supported weight of **50kg**
-  Maximum supported weight in upper tray: **2kg**
-  Maximum supported weight in lower tray: **5kg**
-  VESA **100x100 from 600x400mm**
-  TV height adjustments: 101.7-141.7cm
-  Vertical tilting (TILT): +15° to -15°
-  Locking wheels
-  Internal cable passage
-  Webcam mount



### A06V4\_TP

-  Designed for use with TVs between **32" and 55"**
-  Maximum supported weight of **35kg**
-  VESA **100x100 from 400x400mm**
-  Non-slip feet
-  Height adjustments between 110 and 170cm

# AUDITORIUM. CLASSROOM. MEETING ROOM.

Transform your space into a  
**dynamic, interactive environment.**

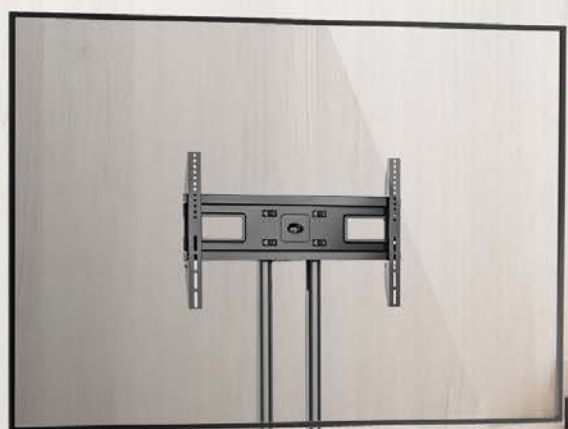

DISCOVER ALL OUR MODELS.

- LVW02-46T
- LVW02-46F

- A06V4\_TP
- A06V6\_S

- A06V6\_PRO





# WALL MOUNTS PROJECTORS AND TV CEILING MOUNTS



Simplified Installation



Optimized space







Safety





### PRO1100B BLACK PRO1100W WHITE

-  Maximum supported weight of **13,5Kg**
-  Aluminum and carbon steel structure
-  Distance from the ceiling between 54,5 a 90cm
-  Horizontal and vertical angle adjustment +15° to -15°
-  4-point fastening (increased safety)

360° horizontal swivel

Internal cable passage









### PRO100B BLACK PRO100W WHITE

-  Maximum supported weight of **13,5Kg**
-  Aluminum and carbon steel structure
-  Ceiling distance 15 cm
-  Horizontal and vertical angle adjustment +15° to -15°
-  4-point fastening (increased safety)

360° horizontal swivel



### A05V6

-  Designed for use with TVs between **26" and 75"**
-  Maximum supported weight of **68kg**
-  VESA **100x100 from 600x400mm**
-  Distance from ceiling: 72 a 159cm
-  Vertical TILT from +5° a -15°
-  Rotation between -30° to +30° (left/right)
-  Internal cable passage



A COMPLETE RANGE OF  
MOUNTS—COUNT ON  
ELG TO HAVE IT ALL.



## WALL MOUNTS OVEN RACK MOUNTS

Versatility is the key



Pre-assembled with a  
3-step installation



Slim profile



Discreet and  
clean design



Microwave



Electric oven



Air-friers

MW05SL



MW05WH



## MW05SL / MW05WH



Maximum supported weight of **30Kg**



Support for microwave feet



Non-slip system



Simplified installation, safety and practicality



Telescoping rods allowing adjustments between 28,4 and 41,4 cm



Fastening rod wall height of 13,5 cm



Installation in 3 simple steps



Ultra slim profile



Discrete and clean design

MOUNTS FOR  
MICROWAVES,  
ELECTRIC OVENS  
AND EVERYTHING YOU NEED.





## WALL MOUNTS **RECEIVER CONVERTER**

Organization in any environment



Simplified Installation







Optimized space



Practicality







### ACE08S

-  Maximum supported weight of 6kg
-  Fastens onto TV itself
-  Reinforced plastic rack
-  Rack Dimensions **18x12,7cm**



### ACE08D

-  Maximum supported weight of 6kg
-  Fastens onto TV itself
-  Reinforced plastic rack
-  Rack Dimensions **30x12,7cm**

PRACTICAL AND SLEEK.  
THE ADJUSTABLE CONVERTER  
MOUNT FITS TVS OF ALL  
SHAPES AND SIZES.



# What's the ideal mount for your TV?

Our models meet various installation profiles and suit different environments.

CARACTERISTICAS	FIXED	TILTING	FULL MOTION	PEDESTAL	CEILING MOUNTS
<b>SIMPLIFIED INSTALLATION</b> Installation in a few simple steps. Factory assembled mount.	✓	✓	✓	✓	✓
<b>HIGH-LEVEL SAFETY STANDARDS</b> Highest level resistance on the market. Safe highly-resistant installation.	✓	✓	✓	✓	✓
<b>SIMPLIFIED CABLE ACCESS</b> Move TV away from wall to access cables behind TV.		✓	✓	✓	✓
<b>GLARE CORRECTION</b> Vertical adjustment for a comfortable and glare-free view.		✓	✓	✓	✓
<b>COMPLETE RANGE OF MOTION</b> Complete range of motion. Forward and backward movements, vertical tilt and TV level adjustment.			✓		✓

## VESA Compatibility Table

VESA stands for **Video Electronics Standards Association**. This is the set of standards that defines the distance between the mounting holes on the back of a monitor or TV.

Use the compatibility chart below to identify your mount's VESA standard according to the size of your TV.

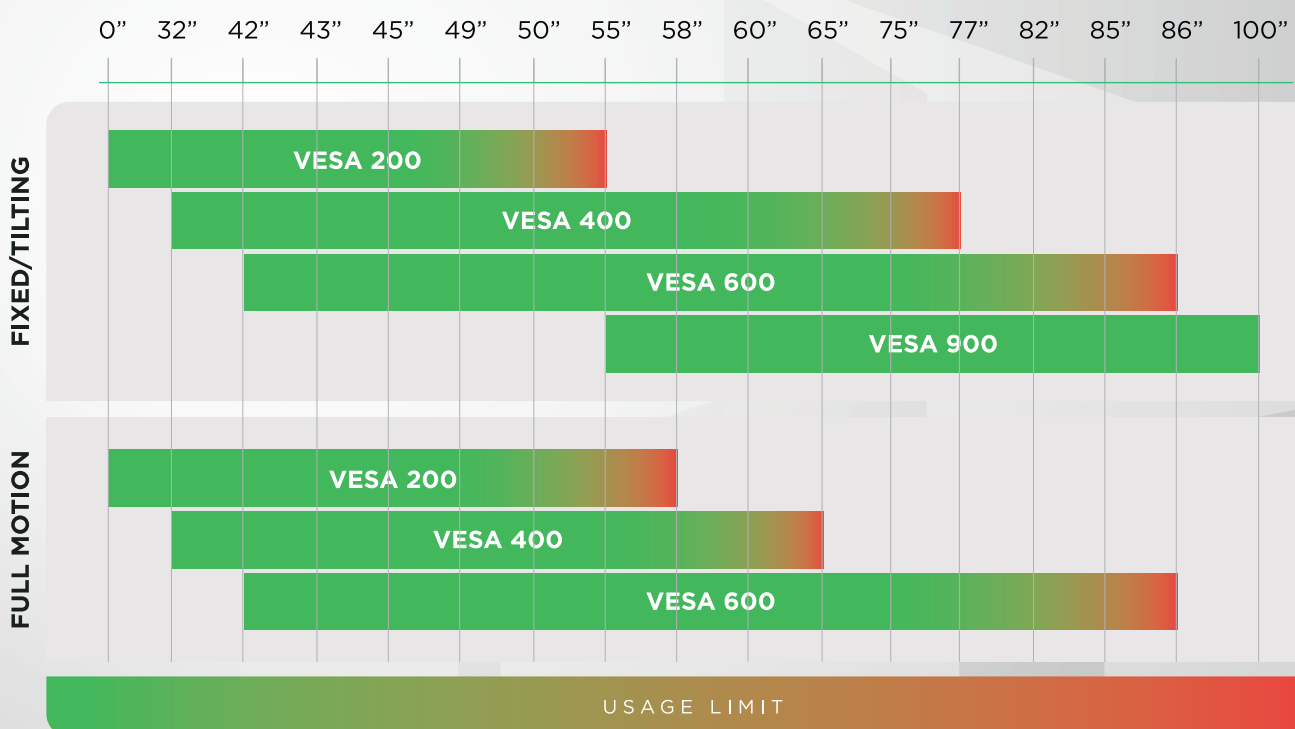

Grab the popcorn,  
it's movie time!.

# ELG MOUNTS FOR **GIANT** **SCREENS**

strength and technology to secure  
your big screen.

Explore our line of mounts for TVs up  
to 120", designed to deliver the  
ultimate viewing experience in any  
room.

DISCOVER ALL OUR MODELS.

- A03V8XL
- A02V8XL
- N01V8
- A02V8N
- A02V9XL





## DIGITAL ANTENNAS **INTERNAL AND EXTERNAL**

Sharper images, crystal-clear sound, unmatched signal



4K ready



100% digital  
image and sound



Long range  
reception



UV ray and  
water resistant



Premium  
material



360° signal capture



Compatible with any TV and Converter



High-definition sound and image



Smart boost signal smart reception technology

**SMART BOOST**

5 in 1





**5 in 1**  
4K, HDTV, VHF, UHF, FM

4k Ready



## HDTVEX500PLUS





Falcon

-  External Antenna
-  Installation accessories included
-  10m coaxial cable included
-  High signal reception performance with 7dBi gain
-  Robust and durable structure. Weather-resistant and waterproof surface



## HDTVEX800PLUS

Wave

-  External Antenna
-  Installation accessories included
-  10m coaxial cable included
-  High signal reception performance with 8dBi gain
-  Robust and durable structure. Weather-resistant and waterproof surface









### HDTV1300I Smart View

-  Internal antenna
-  Pre-assembled (PLUG & PLAY)
-  High signal reception performance with 4dBi gain
-  2.5m coaxial cable included
-  Magnetic Base







### HDTV1500 Shark

-  Internal antenna
-  Pre-assembled (PLUG & PLAY)
-  Exclusive, efficient and modern design
-  1.5m coaxial cable included
-  Double-sided fastening tape included
-  High signal reception performance with 5dBi gain









### HDTV3000 Shark+

-  Internal antenna
-  Pre-assembled (PLUG & PLAY)
-  Exclusive, efficient and modern design
-  3.0m coaxial cable included
-  Double-sided fastening tape included
-  High signal reception performance with 5dBi gain



### HDTVSLIM50 Fit

-  Internal antenna
-  Ultra slim design
-  Pre-assembled (PLUG & PLAY)
-  Exclusive, efficient and modern design
-  1.5m coaxial cable included
-  Double-sided fastening tape included
-  High signal reception performance with 6dBi gain

Antennas and cables that take your audio and video to the **next level.**

Enjoy high-definition picture and sound, with every detail in perfect clarity. With ELG antennas and HDMI cables, maximize your TV's potential with top-quality technology. Explore our models and elevate your entertainment experience.



- HDTV1500 antenna
- HS8K20 cable

**elg** <sup>®</sup>  
SOLUÇÕES  
INTELIGENTES



## CABLES

# AUDIO AND VIDEO

A new level in sound and image standards



8K LH



Copper  
conductors



Wide range  
compatibility



Gold plated  
connectors



High definition



Ethernet



Premium  
materials

## HDMI 4K



**HD4K15** 1,5 METER    **HD4K25** 2,5 METERS    **HD4K50** 5 METERS  
**HD4K100** 10 METERS    **HD4K150** 15 METERS

HDMI 2.0 Cable

- 4K/60Hz Ultra HD
- Full HDTV
- 100Mbps ETHERNET Channel
- Audio return channel (ARC)
- 24K Gold Plated Connectors
- HDR Ready
- 18 Gbps broadband

## HDMI 8K



**HD8K15** 1,5 METERS    **HD8K25** 2,5 METERS    **HD8K50** 5 METERS

HDMI 2.1 Cable

- 8K Ultra HD / 4K / UHD TV
- 8K/60Hz; 4K/120Hz; 1080/144Hz
- High-speed ETHERNET channel
- 19 Pins + 1 Ground
- 24K Gold Plated Connectors
- Oxygen Free
- Enhanced Audio Return Channel (eARC)
- HDR Ready
- Ultra High Speed 48 Gbps

## HDMI 4K



**HD15** 1,5 METER    **HD25** 2,5 METERS    **HS1018** 1,8 METER  
**HS2030** 3 METERS    **HS2050** 5 METERS    **HS20100** 10 METER

HDMI 2.0 Cable









- 4K/60Hz Ultra HD
- Full HDTV
- 100Mbps ETHERNET Channel
- Audio return channel (ARC)
- 24K Gold Plated Connectors
- HDR Ready
- 18 Gbps broadband

## HDMI 8K



**HS8K20** 2 METER    **HS8K30** 3 METERS

### HDMI 2.1 Cable

-  8K Ultra HD / 4K / UHD TV
-  High-speed ETHERNET channel
-  24K Gold Plated Connectors
-  Ultra High Speed 48 Gbps
-  8K/60Hz; 4K/120Hz; 1080/144Hz
-  Ballistic Nylon Coating
-  Triple Shield Protection
-  Enhanced Audio Return Channel (eARC)
-  HDR Ready

## DISPLAY PORT



**DP1420** 2 METERS

### 8K 1.4V DisplayPort Cable





-  8K Ultra HD / 4K / UHD TV
-  24K Gold Plated Connectors Ultra
-  Ultra High Speed 32.4 Gbps
-  8K/60hz; 4K/144Hz
-  Connector with Safety Lock
-  GDR10 Compatible

## ÓPTICO



**T5018HD** 3 METERS

### Optical Cable with Toslink Connectors

-  24K gold plated Toslink connectors
-  Crystal Clear Audio
-  High-quality 100% digital audio
-  Multi-Channel
-  Plug & Play

## P2



**P3510HD** 1 METER    **P3520HD** 2 METERS

Stereo Audio Cable P2 x P2

 P2xP2 stereo 3.5mm audio cable

 High Definition Sound

 Aluminum Finish

 Copper filaments

 Velcro included

 Cable organizer included



CINEMATIC IMAGES  
WITH UNMATCHED  
RESOLUTION

TRIPLE-SHIELDED CABLES PROVIDE MAXIMUM PROTECTION, FEATURING **100% PURE COPPER CONDUCTORS**. GOLD-PLATED **CONNECTORS WITH A 24K FINISH** ENSURE EXCEPTIONAL DURABILITY AND RESISTANCE TO OXIDATION.



# SMARTPHONES **ACCESSORIES**

Exceptional performance and guaranteed safety with ELG smartphone accessories. Our cables and chargers deliver fast charging and smart usage, offering broad compatibility and extra power to keep your devices running strong.







## SMARTPHONES ACCESSORIES

# CABLES

Premium materials for durability and speed



Extra shielding



Ultraflexible



Designed for Faster  
and Safer Charging



Short-circuit  
protection



Overheating  
protection



Cables highly  
resistant to bending



Charging and  
data transfer



Wide compatibility  
range

High performance charging



Efficiency in data transmission



High conductivity copper filaments



Laser welded reinforced connectors



Cable organizer included



1-year warranty



**TC60** 1 METER   **TC60B** 1 METER

White    Black

**TC602** 2 METERS

White

USB-C to USB-C

3A / 60W

Ultra fast charging

Ultra high resistant braided nylon coating (high folding resistance)

NEW RELEASE



**TC2TC** 1 METER   **TC2TCM** 2 METERS

USB-C to USB-C

3A / 15W

Super fast charging

High-strength PVC coated cable (high bending resistance)



**TCUSB** 1 METER   **TCUSB2** 2 METER

USB-A to USB-C

3A / 15W

Super fast charging

High-strength PVC coated cable (high bending resistance)



**TC12W**   **TC12R**   **TC12X**   **TC12T**

- Branco
- Salmon
- Purple
- Blue



 USB-A to  USB-C

 3A / 15W

 1,2 meter length

 Super fast charging

 High-strength PVC coated cable (high bending resistance)



**TC10BL**

 USB-A to  USB-C

 3A / 15W

 1 meter length

 Super fast charging

 Ultra high resistant braided nylon coating (high folding resistance)

 Ballistic nylon cable



**TC20BG**

 USB-A to  USB-C

 3A / 15W

 2 meters length

 Super fast charging

 Ultra high resistant braided nylon coating (high folding resistance)

 Metallic finish



**ELMC10LBE** 1 METER   **ELMC10WH** 1 METER   **ELMC20WH** 2 METERS

- Turquoise
- White
- White

 USB-A to  USB-C

 3A / 15W

 Super fast charging

 Ultra flexible flat rubber cable (high folding resistance)



**TCL10P-BR** 1 METER    **TCL20P-BR** 2 METERS

White

White

LANÇAMENTO

**TCL10B** 1 METER

Black

USB-C to 8-pin Lightning

3A / 27W

Ultra fast charging

Ultra high resistant braided nylon coating (high folding resistance)



**L810PD** High Performance POWER DELIVERY TECHNOLOGY with fast charging

USB-C to 8-pin Lightning

3A / 15W

1 meter length

Super fast charging

High-strength PVC coated cable (high bending resistance)



**TCL10** 1 METER    **TCL20** 2 METERS

USB-C to 8-pin Lightning

3A / 15W

Super fast charging

High-strength PVC coated cable (high bending resistance)



**L810** 1 METER    **L820** 2 METERS

USB-A to 8-pin Lightning

2,4A / 12W

Fast charging

High-strength PVC coated cable (high bending resistance)



### L812W

○ White

### L812R

● Salmon

### L812X

● Purple

### L812T

● Blue



USB-A to 8-pin Lightning

⚡ 2,4A / 12W

↔ 1,2 meter length

+⚡ Fast charging

🔌 High-strength PVC coated cable (high bending resistance)



### L810PB

USB-A to 8-pin Lightning

⚡ 2,4A / 12W

↔ 1 meter length

+⚡ Fast charging

🔌 Ultra flexible flat rubber cable (high folding resistance)



### L820BG

USB-A to 8-pin Lightning

⚡ 2,4A / 12W

↔ 2 meters length

+⚡ Fast charging

🔌 Ultra high resistant braided nylon coating (high folding resistance)

🌀 Metallic finish



### XFT810RD

USB-A to 8-pin Lightning

⚡ 2,4A / 12W

↔ 1 meter length

+⚡ Fast charging

📏 90° connector increased protection

📄 Micro textured finish High-strength

📄 PVC coated cable (high bending resistance)



### M510BY

USB-A to Micro USB

⚡ 2,4A / 12W

📏 1 meter length

⚡+ Fast charging

🌀 Ultra high resistant braided nylon coating (high folding resistance)

🌀 Metallic finish



### M512W

○ White

### M512R

● Salmon

### M512X

● Purple

### M512T

● Blue



USB-A to Micro USB

⚡ 2,4A / 12W

📏 1,2 meter length

⚡+ Fast charging

🌀 High-strength PVC coated cable (high bending resistance)



### M510 1 METER M518 1,8 METER

USB-A to Micro USB

⚡ 2,4A / 12W

⚡+ Fast charging

🌀 High-strength PVC coated cable (high bending resistance)



### 31CBK

USB-A to Lightning 8 pins  
+ Micro USB + USB-C

📏 Lightning 8 pins 2,4A / 12W

📏 Tipo-C 3A / 1.5W

📏 Micro USB 2,4A / 12W

📏 1,2 meter length

📏 3-in-1 cable

🌀 Ultra high resistant braided nylon coating (high folding resistance)



### CS-31CZ

USB-A to Lightning 8 pins  
+ Micro USB + USB-C

📏 8-pin 2,4A/12W Lightning connector

📏 Type-C 3A / 1.5W

📏 Micro USB 2,4A/12W

📏 1,2 meter length

📏 3-in-1 cable

🌀 Ultra high resistant braided nylon coating (high folding resistance)





### PW31C

USB-A to Lightning 8 pins  
+ Micro USB + USB-C

⚡ 2,4A / 12W

📏 1,5 meter length

🔌 3-in-1 cable

🔊 High-strength PVC coated cable (high bending resistance)



### USBEXT1

USB 3.0 Extension 5GBps USBA-A Male/Female Connector

🖨️ USB 3.0 5GBps

🔄 Transfer photos, videos, music

📏 100% copper 24 + 28 AWG

📁 Rapid data transfer

🔌 Wide compatibility range

📏 PVC finish

🎮 Plug & Play

📏 1,5 meter length

🖨️ Designed for use with pen drive, gamer control, mouse, laptop, keyboard, tablet, external HD...



### USBADP1

Adaptador OTG USB Tipo-C USB Fêmea

🖨️ USB 3.0

📁 Rapid data transfer

🔌 OTG (On the Go) Technology

📏 Rapid data transfer

🔌 Wide compatibility range

📏 20 centimeters length

🎮 Plug and Play

🖨️ Designed for use with pen drive, gamer control, mouse, laptop, keyboard, tablet, external HD...

🔄 Transfer photos, videos, music



### ADP8P3

P3 Auxiliary Lightning Audio Adapter Cable

🎤 Microphone compatible

🔊 High-definition audio streaming

📱 Maintains smartphone functionality

🔌 Lightning connector to 3.5mm audio adapter

📏 8,5 centimeters length



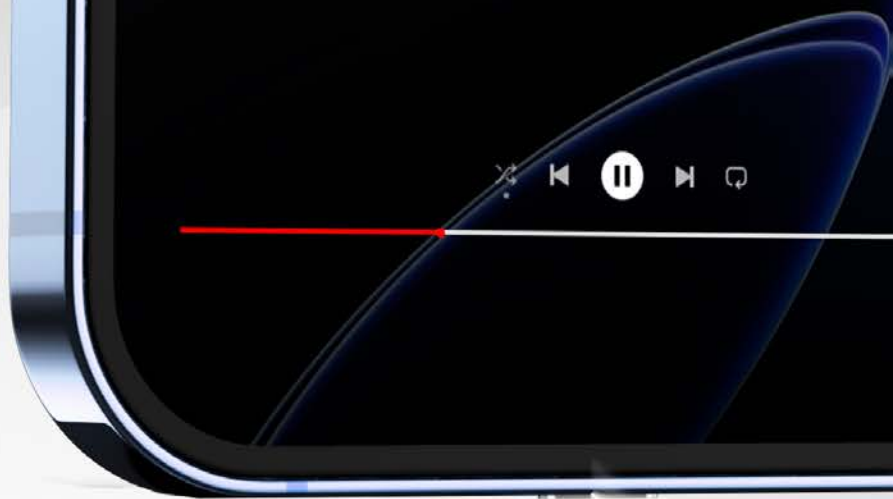

• W65GAN



• CC2STC



## FAST CHARGING FOR YOUR EVERYDAY NEEDS

Our cables and chargers deliver top performance with Power Delivery, Quick Charge, and GaN technologies, ensuring durability and safety with every connection.

Power Delivery guarantees efficient charging, Quick Charge reduces wait time, and GaN technology provides compactness and energy efficiency, keeping your devices ready when you need them most.

### DISCOVER ALL OUR MODELS

- TC60
- TCL20P-BR
- CC2STC
- WC1S-QC3
- W35GAN
- TCL10P-BR
- TCL10B
- WCPD
- WC2S-PDQC
- W65GAN

**WCPD**



**W35GAN**



**W65GAN**

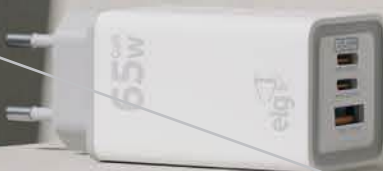

## SMARTPHONES ACCESSORIES **WALL CHARGERS**

Safety and smart design



Efficiency  
and safety



Designed for faster  
and safer charging



Short-circuit  
protection



Overheating  
protection



Flame resistant  
material



High conductivity

Compatible with tablets, smartphones and other devices that can be recharged via USB port



Automatic bivolt

**BIVOLT**  
127v ⚡ 220v

Anatel homologation certificate



1-year warranty



### W35GAN

⚡ GAN TECHNOLOGY - Higher efficiency and faster charging

- 🔌 GaN PD/QC 3A / 35W charger
- 🔌 USB-A: 5V 3A, 9V 2A, 12V 1.5A (QC 3.0)
- ⚡ Quick Charge and Power Delivery Protocol
- ⚡ Input: (100 - 240V 50/60Hz MAX 1.2A)
- 📄 2 USB ports
- +⚡ Up to 3x faster loading
- 🔌 USB-C: 5V 3A, 9V 3.0A, 12V 2.5A, 15V 2A, 20 1.5A (PD)
- 📈 Greater Efficiency



### W65GAN

⚡ GAN TECHNOLOGY - Higher efficiency and faster charging

- 🔌 GaN PD/QC 3A / 35W charger
- 🔌 USB-A: 5V 3A, 9V 3A, 12V 3A 20V 1.5A (QC 3.0)
- ⚡ Quick Charge and Power Delivery Protocol
- ⚡ Input: (100 - 240V 50/60Hz MAX 1.5A)
- 📄 3 USB ports
- +⚡ Up to 3x faster loading
- 🔌 USB-C 1 and 2: 5V 3A, 9V 3A, 12V 3A, 15V 3A, 20 3.25A (PD)
- 📈 Greater Efficiency



### WCPD

High Performance POWER DELIVERY TECHNOLOGY with rapid charging



PD charger 3A / 20W



Input: (110 - 240V 50/60Hz  
MAX 0.15A)



Power Delivery protocol

USB-C port: 5V 3A DC, 9V 2.22A,

12V 1.67A / PPS: 3.3-5.9V 3A,  
3.3-11.2V 1.8A



### WC1S-QC3



QC charger 3A / 18W



Input: (110 - 240V 50/60Hz  
MAX 0.15A)



Quick Charge protocol



USB-A port: 5V 3A DC, 9V 2A,  
12V 1.5A (18W QC)



### WC2S-PDQC

High Performance POWER DELIVERY TECHNOLOGY with rapid charging



PD/QC charger 3A / 18W



USB-C: 5V 3A, 9V 2.0A,  
12V 1.5A (PD)



Quick Charge and Power  
Delivery protocol



USB-A: 3.6-6.5V 3A, 6.5-9V  
2.0A, 9-12V 1.5A (QC)



Extra 3A boost



2 USB ports



Input: (127 - 220V 50/60Hz  
MAX 0.6A)



### GaN TECNOLOGY

Advanced technology using innovative materials for **greater energy efficiency**, **ultra-fast charging**, and a compact design that **optimizes performance**.

### PD POWER DELIVERY TECNOLOGY



**Smartly adjusts power** to charge your devices **quickly and safely**.

### QC QUICK CHARGE TECNOLOGY

**Turbocharging** made efficient, drastically **reducing recharge time** for compatible devices.





### WC1APT

-  1A charger
-  USB-A port: 5V 1A DC

 Input (127 - 220V 50/60Hz MAX 0,5A)



### WC1A

-  2.1A charger
-  USB-A port: 5V 2.1A DC

 Input (110 - 240V 50/60Hz MAX 0.15A)



### WC124A

-  1A / 2.1A charger
-  2 USB ports



 USB-A 1: 5V 1A DC

 USB-A 2: 5V 2.1A DC

 Input (127 - 220V 50/60Hz MAX 0.5A)



### W124C

-  2.1A charger
-  2 USB ports

 USB-A: 5V 2.1A DC

 USB-C: 5V 2.1A DC

 Input (110 - 220V 50/60Hz MAX 0.5A)



### WC3S

- 1A / 2.4A charger
- 3 USB ports
- USB-A 1: 5V 1A DC
- USB-A 2: 5V 1A DC
- USB-A 3: 5V 2.4A DC
- Input (127 - 220V 50/60Hz MAX 0.5A)
- Designed for Faster and Safer Charging
- High conductivity material



### KTC10WC

#### USB-C Kit Charger + Cable

NEW RELEASE

- Compatible with USB-C connector
- USB-C cable 2.4A 12W 1 meter
- USB-A port: 5V 2.1A DC
- Cable organizer included



### KT810WC

#### Kit Lightning Carregador + Cabo

NEW RELEASE

- Lightning connector compatible with iPhone, iPad, AirPods, etc
- Lightning cable 2.4A 12W 1 Meter
- USB-A port: 5V 2.1A DC
- Cable organizer included



### KT510WC

#### Kit Micro USB Carregador + Cabo

NEW RELEASE

- Micro USB compatible with Android
- Micro USB cable 2.4A 12W 1 Meter
- USB-A port: 5V 2.1A DC
- Cable organizer included

# Imagine a powerful **Power Bank** with a battery that **never wears out**

It's here! Discover ELG's options for  
reliable, long-lasting power.



**TURBO CHARGING**  
50% battery in  
just 35 minutes.

**BATTERY SAVER**  
Optimized cycles to  
prevent battery wear.



EXPLORE ALL OUR MODELS NOW!

- PB102BK - 10.200mAh
- PB102WH - 10.200mAh
- PB200BK - 20.200mAh





## SMARTPHONES ACCESSORIES

# POWER BANK CHARGERS

Your devices with much more power



4.5A Turbo Charging, Power Delivery  
and Quick Charge



Charges up to 3 devices  
simultaneously



Integrated digital LCD  
display with risk protectio



Protection against  
battery stuffing



Compatible with tablets, smartphones and other devices that can be recharged via USB port



Inputs: Micro USB or USB-C: 5V 3A - 9V 2A DC 12V 1.5A (USB-C cable 30cm included)



USB-C output: 5V 3A, 9V 2.22A, 12V 1.67A (PD)



USB-A outputs: 5V 4.5A, 9V 2.22A, 12V 1.5A (QC)



Textured surface



Up to 300 recharging cycles with a rated capacity



Anatel homologation certificate



Overheating, overload and short circuit protection



1-year warranty



### PB102BK PB102WH

● Black

○ White

#### Power Bank 10200Mah

Power Bank 10200mAh 22.5W portable charger

45+ h for devices fitted with 1500mAh battery and that use USB port for recharging



### PB200BK

#### Power Bank 20000Mah

Power Bank PRO 20000mAh 22.5W Portable Charger

90+ h for devices fitted with 1500mAh battery and that use USB port for recharging



## SMARTPHONES ACCESSORIES

# INDUCTION CHARGERS

The newest generation of chargers



Wireless  
charging



Compatible with  
Qi technology



Ultra Fast  
Charging



Interference-Free  
charging



Short-circuit  
protection



Overheating  
protection

Compatible with tablets, smartphones and other devices that can be charging wirelessly using Qi technology



Anatel homologation certificate



High conductivity material



1-year warranty



Output: 5W, 7.5W, 10W and 15W



Flame resistant material



### WQ2WH

15W Safemag Wireless Magnetic Charger

 Magnetic contact, perfect for movies and games

 Input: 5V 3A - 9V 2A DC

 1 meter USB-C cable



### WQ15BK

15W Wireless Charger

 Input: 5V 2A DC

 1 meter USB-A cable



## SMARTPHONES ACCESSORIES

# VEHICLE CHARGERS

Safety and speed for charging during your travels



Designed for faster  
and safer charging



Short-circuit  
protection



Flame resistant  
material



Overheating  
protection

Compatible with tablets, smartphones and other devices that can be recharged via USB port



LED operating indicator



Anatel homologation certificate



Input: 12 - 24V DC



1-year warranty



### CC2S

○ White

### CC2SPT

● Black

## Universal Vehicle Charger



2.1A charger



USB-A 2: 5V 2.1A DC



2 USB ports



High conductivity material



USB-A 1: 5V 2.1A DC



### CC2STC

## Universal Vehicle Charger



3.1A charger



USB-A: 5V 3.1A DC



2 USB ports



Quick Charge Technology



USB-C: 5V 3.1A DC

PERFECT FOR FAST,  
SECURE CHARGING.









SMARTPHONES ACCESSORIES  
**CAR PHONE HOLDERS**

Safe and smart viewing of your smartphone



### CH358A





#### Car Phone Holders Automatic Clamp Type - Air Vent

-  Supports smartphones with a 4.5" to 7" screen
-  Allows for screen rotation (vertical/horizontal)
-  Automatic cell phone locking system
-  Articulating claw
-  Rubberized handles and supports
-  Fastens to air vent



### CH358V







#### Car Phone Holders Automatic Clamp - Air Vent

-  Supports smartphones with a 4.5" to 7" screen
-  Allows for screen rotation (vertical/horizontal)
-  Automatic cell phone locking system
-  Articulating claw
-  Rubberized handles and supports
-  Fastens to dashboard or windshield
-  Suction cup fastening system



### CH360WA

#### Car Phone Holder Wireless Charger - Air Vent

-  Supports smartphones with a 4.5" to 7" screen
-  80cm power cable included (Micro USB)
-  Wireless charging
-  Articulating claw
-  10W (Max)
-  Fastens to air vent
-  Rubberized handles and supports



### CH360WV

#### Car Phone Holder Wireless Charger Suction Cup system

-  Supports smartphones with a 4.5" to 7" screen
-  80cm power cable included (Micro USB)
-  Wireless charging
-  Articulating claw
-  10W (Max)
-  Fastens to dashboard or windshield
-  Rubberized handles and supports
-  Suction cup fastening system



## HEADPHONES HEADSETS AND IN-EAR WIRED HEADPHONES

The perfect connection between sound and comfort



High fidelity  
sound



Noise isolation



Powerful bass and  
treble



Quality



Design



Premium material



Plug & Play





**EPB-MAX5BE**

● Blue

**EPB-MAX5BK**

● Black

**EPB-MAX5WH**

○ White

Headset With Wireless Microphone (Bluetooth)



Lightweight anatomical design



Bluetooth 5.1



USB Type-C



50mm Driver



Auto Connect



Battery autonomy of up to 20 hours



3.5mm AUX audio input



**TWPRO3S**

Bluetooth Earbud Headphones with Microphone



Ideal for day-to-day use



Bluetooth 5.3



Battery autonomy of up to 12h



Auto Connect



USB Type-C



Touch commands



Call feature



13mm drivers











Bass boost



## TWSP2

### Bluetooth Earbud Headphones with Microphone









-  Ideal for use during exercise/in gym settings
-  Button commands
-  Bluetooth 5.3
-  Splash resistant
-  Battery autonomy of up to 9h
-  Bass boost
-  Auto Connect
-  Battery autonomy of 20 hours
-  USB Type-C



## EPTCBK

### USB Type-C Earbuds with Microphone

NEW RELEASE





-  Anatomical and comfortable fit
-  High-definition bass and treble
-  Built-in high sensitivity microphone
-  Silicone tips (S/M/L)
-  High-level audio fidelity
-  USB TYPE-C connector
-  Noise-cancelling feature
-  20 horas de Autonomia
-  Complete control with a single button: Play/Pause, Skip forward/backward



## EP12BK EP12WH

● Black ○ White

### Earbuds with Microphone

-  Anatomical and comfortable fit
-  Noise-cancelling feature
-  Built-in microphone
-  Silicone tips (S/M/L)
-  High-level audio fidelity
-  Complete control with a single button: Play/Pause, Skip forward/backward



### STR05GK

● Green





### STR05BK

● Blue

### STR05RB

● Red

#### Earbuds with Microphone

-  Anatomical and comfortable fit
-  Built-in microphone
-  High-level audio fidelity
-  Complete control with a single button: Play/Pause, Skip forward/backward
-  Noise-cancelling feature
-  High-definition bass and treble
-  Silicone tips (S/M/L)
-  Conector P3 3,5mm



### STR11B

● Blue

### STR11R

● Red

### STR11K

● Black





#### Earbuds with Microphone

-  Anatomical and comfortable fit
-  Built-in microphone
-  High-level audio fidelity 360
-  Noise-cancelling feature
-  Silicone tips (S/M/L)
-  3.5mm P3 Connector
-  Complete control with a single button: Play/Pause, Skip forward/backward



### AAVGP3

#### P2/P3 Headset Audio Adapter

-  Gold plated connectors
-  High fidelity sound
-  Laser welded connector
-  Extra Shielding
-  Auxiliary Input Cable

**HUB41C-V2**



**HUB41A-V2**



**HUB41HD-V2**



# ADAPTERS HUBs

One connection, multiple possibilities



OTG  
tecnology



Practicality



High resolution



Quality



Design



Premium material



Plug & Play



### HUB41A-V2 4 In 1 USB Hub Adapter

- Allows for use of 4 simultaneous ports
- OTG tecnologia
- USB-C connection
- 1x USB-A 3.0 (data and charge)
- 3x USB-A 2.0
- USB-C to USB-A adapter included
- Aluminum Body and Connector
- Plug & Play, driver-free



### HUB41C-V2 4 In 1 USB Hub Adapter

- Allows for use of 4 simultaneous ports
- OTG tecnologia
- USB-C connection
- 1x USB-A 3.0 (data and charge)
- 1x USB-C
- 2x USB-A 2.0
- USB-C to USB-A adapter included
- PVC body
- Plug & Play, driver-free



### HUB41HD-V2 4 In 1 USB Hub Adapter

- Allows for use of 4 simultaneous ports
- OTG tecnologia
- USB-C connection
- 1x USB-A 3.0 (data and charge)
- 1x USB-C
- 1x USB-A 2.0
- 1x HDMI 4K
- USB-C to USB-A adapter included
- Aluminum body and connector
- Plug & Play, driver-free



### ADTCHD1 USB Type-C to HDMI Converter (Male Connector)

NEW RELEASE

- 4K@60Hz Resolution
- Metal Body and Connector
- 2 meters cable
- High Fidelity Image
- Plug & Play, driver-free

# UNLEASH YOUR POTENTIAL

Adapters and hubs designed for seamless connectivity with tablets, phones, and laptops—expand your device's possibilities effortlessly.

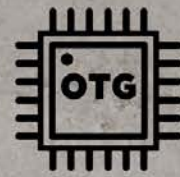

Technology OTG  
in every port



Charging



Data transfer



Multi-device



DISCOVER ALL OUR MODELS

- HUB41A-V2
- HUB41C-V2
- HUB41HD-V2
- ADTCHD1





## ADHDVG2

### HDMI to VGA Converter (Female Connector)

NEW RELEASE

- Gold plated connector
- 15cm cable length
- Full HD resolution
- Plug & Play, driver-free
- High Fidelity Image



## HUB41RJ

### 4 In 1 USB Hub Adapter with Rj45

NEW RELEASE

- Allows for use of 4 simultaneous ports
- OTG tecnologia
- USB-A connection
- 3x USB-A 2.0
- 1x RJ45 (100Mbps)
- USB-A to USB-C Adapter included



## HUB51SD-V2

### Adaptador Hub USB 5 Em 1

- 5 portas simultâneas
- Tecnologia OTG
- 3x USB 2.0
- 1x Mini SD Card
- 1x Micro SD Card
- Conexão USB-A
- Acompanha adaptador USB-A para USB-C
- Plug & Play, sem drivers

NEW RELEASE



## ADDPHD2

### Conversor DisplayPort Para HDMI

- Resolução 4K@60Hz
- Design Compacto
- Conector banhado a ouro
- High Fidelity Image
- Plug and Play, sem drivers



# ALLOCACOC POWER CUBES

Your style in endless possibilities



Innovative design



Child safety feature  
(child-proof lock)



Available in more  
than 90 countries



Resettable 10A  
circuit breaker

**110V  
220V**

Automatic  
bivolt



Flameproof  
structure



Designed by Allocacoc  
Reddot Award Winner



Innovative design  
sockets never  
blocked



Surges protection



Modular assembly



Distributed by ELG



### PWC-R4SW PowerCube Switch

- ON/OFF button
- Frees up 4 outlets
- Internal copper connectors

INMETRO certified product



- 110V  
220V** Bivolt 127/220V (10A)
- Increased energy savings
- Protection for your devices



### PWC-R5 PowerCube Original

- Frees up 5 outlets
- Internal copper connectors
- 110V  
220V** Bivolt 127/220V (10A)

INMETRO certified product



### PWC-R4U PowerCube Original USB

- Frees up 4 outlets
- 2 USB-A 2.4 outputs
- Internal copper connectors
- 110V  
220V** Bivolt 127/220V (10A)

INMETRO certified product









**PWC-X5** 1,5 METER  
**PWC-X5** 3 METERS

INMETRO certified product



### PowerCube Extended

-  Frees up 5 outlets
-  Internal copper connectors
-  Bivolt 127/220V (10A)
-  Self-adhesive base included

# POWER CUBE

TOTAL SECURITY FOR  
YOUR ELECTRONICS.

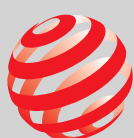

reddot award  
winner

GLOBALLY ACCLAIMED FOR ITS SLEEK,  
**INNOVATIVE CUBE DESIGN**, THE  
POWERCUBE LETS YOU POWER UP ALL  
YOUR DEVICES AT ONCE, **NO PLUGS IN THE  
WAY**. COMPACT, EFFICIENT, AND READY  
TO SIMPLIFY YOUR SETUP!









**PWC-X4U** 1,5 METER  
**PWC-X4U** 3 METERS

INMETRO certified product



## PowerCube Extended

-  Frees up 4 outlets
-  2 USB-A 2.4 outputs
-  Internal copper connectors
-  Bivolt 127/220V (10A)
-  Self-adhesive base included



### **RESETTABLE 10A CIRCUIT BREAKER**

IN CASE OF OVERLOADS OR POWER SURGES, THE SYSTEM **AUTOMATICALLY SHUTS OFF** AND CAN BE **EASILY RESET**.

### **CHILD PROTECTION**

THE **EXCLUSIVE CHILD LOCK SYSTEM** PREVENTS ANY OBJECT FROM BEING INSERTED INTO THE LIVE AND NEUTRAL HOLES, ENSURING SAFETY FOR LITTLE ONES.









OFFICE LINE  
**MOUSEPADS**  
Maximize your comfort



**MPEXL-DG** 90x40cm **MPEL-DG** 60x30cm  
Essential Felt Mousepad with Cup Holder - Dark Gray

NEW RELEASE

-  Felt surface
-  Smooth slide
-  Non-slip base
-  Seamed edges
-  Faux suede cup holder
-  Essential extra large and large

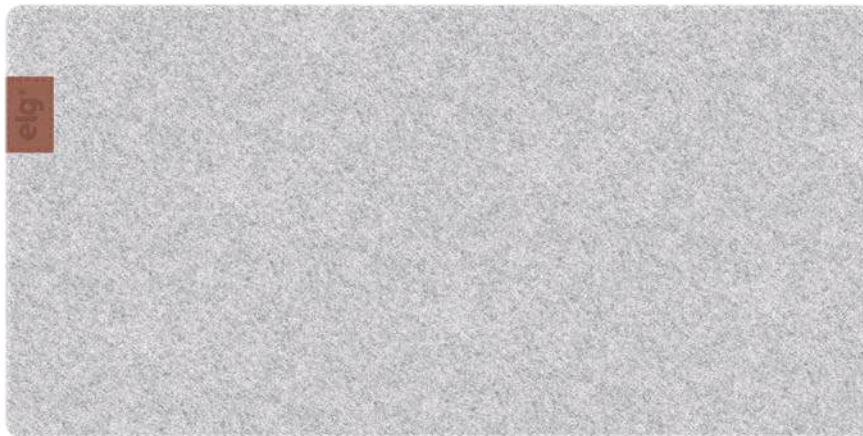

**MPEXL-LG** 90x40cm **MPEL-LG** 60x30cm  
Essential Felt Mousepad with Cup Holder - Light Gray

NEW RELEASE

-  Felt surface
-  Smooth slide
-  Non-slip base
-  Seamed edges
-  Faux suede cup holder
-  Essential extra large and large



## OFFICE LINE CHAIRS

Elegance and ergonomics for your workspace



Design



Confort



Simplified assembly



Quality



Ergonomics



Premium materials



Versatile use



### OCH01

#### Wish Comfort Office Chair

 D28 foam

 Class 2 gas piston

 Chrome base

 Mesh fabric

 Lumbar support



### OCH02

#### Rise Office Chair

 D25 foam

 Class 2 gas piston

 Chrome base

 Mesh fabric

 Lumbar support



### OCH03

#### Grow Office Chair

 D25 foam

 Class 2 gas piston

 Tilt Mechanism

 Chrome base







 Tecido mesh

 Lumbar and Cervical Support



### OCH04







Joy Office Chair

-  D28 foam
-  Class 3 gas piston
-  Tilt Mechanism
-  Base cromada
-  Articulated arm
-  Mesh fabric
-  Lumbar support



### OCH05







Leap Plus Office Chair

-  D27 foam
-  Class 3 gas piston
-  Tilt Mechanism
-  Nylon base
-  Mesh fabric
-  Lumbar support



### OCH06

Leap Office Chair

-  D27 foam
-  Class 3 gas piston
-  Tilt Mechanism
-  Nylon base
-  Mesh fabric
-  Lumbar support





# TRANSFORM YOUR OFFICE WITH **PERFECT ORGANIZATION**

Boost productivity and well-being with a space designed for efficiency and comfort. ELG's smart solutions maximize your workspace and keep everything at your fingertips, creating an environment that elevates your focus, security, and comfort—whether in the office or at home.

• FN80

• SM087

• MPEXL-LG

• PWC-X4U





# GAMING

Enhance your gaming experience by transforming your setup with ELG Gaming chairs, keyboards, mice and headsets. Comfort and precision immerse you in the game, delivering peak performance.

CHAIRS

MOUSES

HEADPHONES

MOUSEPADS

KEYBOARD

KITS





# GAMING CHAIRS

Style and comfort that elevate your setup



Design



Confort



Simplified assembly



Quality



Ergonomics



Premium materials



Versatile use

# SYRAX



Pistão a gás  
classe 3



D30 foam



Class 3 gas piston



Reinforced structure



Nylon base



Breathable leather lining



Lumbar and cervical support

## Technical specifications

Height adjustment	117 to 27cm
Backrest height	75,5cm
Maximum load	120Kg
Base diameter	64cm
Seat width	36 cm
Backrest width	51,5cm
Seat depth	49,5cm



Breathable  
leather  
lining



D30  
foam

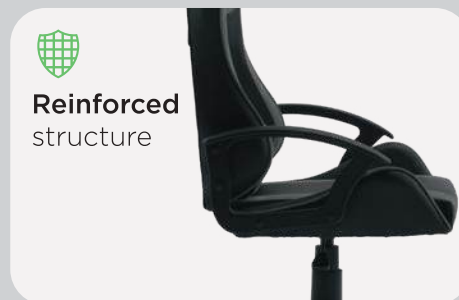

Reinforced  
structure



**CH36BK**  
Black











**CH36BKBL**  
Black and blue



**CH36BKRD**  
Black and red

# DRAKON



-  D30 foam
-  Nylon base
-  Class 3 gas piston
-  Breathable leather lining
-  Butterfly mechanism
-  Lumbar and cervical support
-  135° reclining backrest
-  Reinforced structure
-  Material: synthetic leather

Butterfly mechanism   
 Class 3 gas piston 

### Technical specifications

Height adjustment	121 to 129cm
Backrest height	83cm
Maximum load	140kg
Base diameter	640mm
Seat width	38,5cm
Backrest width	51cm
Seat depth	50cm

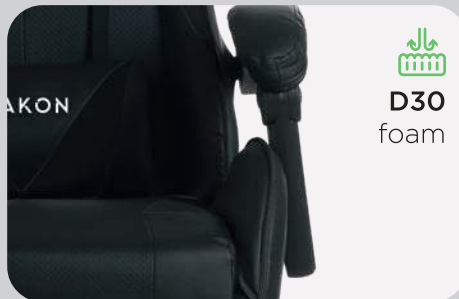
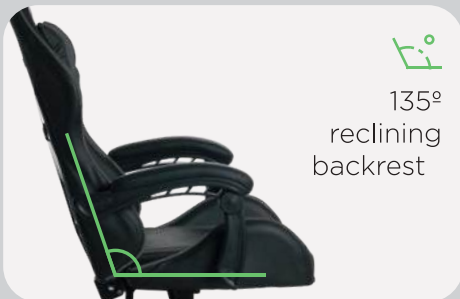

**CH31BK**  
Black



**CH31BKBL**  
Black and blue



**CH31BKRD**  
Black and red



**CH31BKWH**  
Black and white

# BLACK HAWK



D40 foam



Class 4 gas piston



Metal structure



Reclining backrest 180°



Material: PU



Butterfly mechanism



Tilt mechanism



2D Adjustable arm

Butterfly mechanism  
Class 4 gas piston



## Technical specifications

Height adjustment	123 to 133cm
Backrest height	82cm
Maximum load	150kg
Base diameter	70cm
Seat width	35cm
Backrest width	53cm
Seat depth	48cm

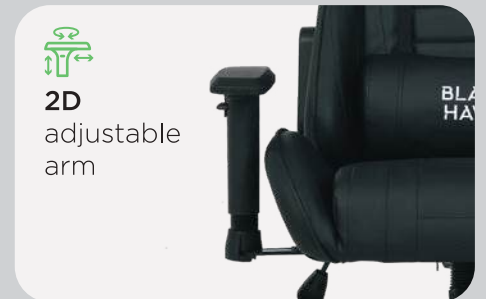

**CH05BK**  
Black



**CH05BKWH**  
Black and white



**CH05BKBL**  
Black and blue

# POLLUX

CH08BKRGB



RGB lighting



3D adjustable arm



D30 Foam



Class 3 Gas Piston



Butterfly mechanism



Material: synthetic leather



135° reclining backrest

## Technical specifications

Height adjustment	117 to 127cm
Backrest height	82cm
Maximum load	150kg
Base diameter	350mm
Seat width	43cm
Backrest width	54cm
Seat depth	49cm

Butterfly mechanism  
Class 3 gas piston

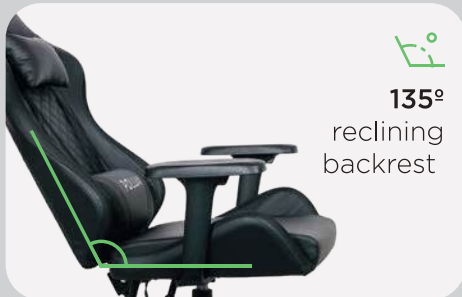

135°  
reclining  
backrest



D30  
foam

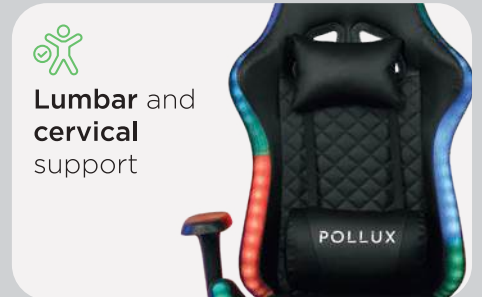

Lumbar and  
cervical  
support

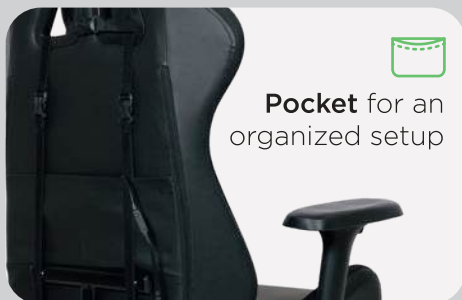

Pocket for an  
organized setup



3D  
adjustable  
arms



Base  
diameter:  
350mm

PLAY FOR HOURS  
WITH MAXIMUM COMFORT  
AND PLENTY OF STYLE!

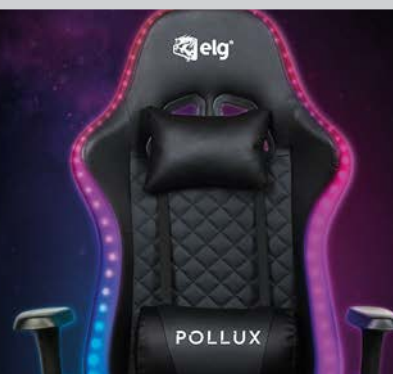



# POLLUX

## ONE CHAIR, ENDLESS POSSIBILITIES!

VERSATILITY IN MILLIONS OF COLORS

With 16 million RGB LED Chroma colors, the Pollux chair brings your setup to life, creating an immersive experience like never before.

Customize your look with the remote control, and game in comfort, style, and ergonomic perfection.



Take control with the remote—pick your color, adjust the brightness, or switch between pre-set effects.

Personalization made easy.

COLLOR EFFECTS



SINGLE COLOR





# GAMING HEADPHONES

Get inside the game



Surround 7.1



High fidelity sound



Bass and powerful  
treble



Full immersion



Microfone crystal clear



Mesh fabric



Design



NEW RELEASE

### TWGVEBK

TWS Bluetooth Earbud Gaming Headphones with Microphone

- 🎮 Ideal for gaming
- 🔌 USB type-C
- 📶 Bluetooth 5.3
- 👆 Touch commands
- 🎧 ANC/ENC
- 💧 Splash resistant
- 🔋 Auto connect
- 🔊 Bass boost



### EPZHBK EPZHGR

● Black ● Greens

Zahhak Earbud Gamer Headset

- 📏 Compact design
- 🔌 P3 connection
- 🎤 Dedicated microphone
- 👛 Transport case
- 👉 Finger gloves Included in box
- 👂 Extra eartips
- 🔊 Reinforced bass



Includes **Gamer Finger Glove**

### EPZHBK EPZHGR

THE PRECISION YOU WANT IS WITHIN YOUR REACH.

Play like a pro with our gaming finger sleeves, designed for **maximum comfort and control**. Ideal for mobile gaming, it boosts your performance and reduces slips.



### HGOR

#### Orion Gaming Headset

- 3D Stereo Sound
- Nylon cable
- Multiplatform
- Cable volume control
- P3 connection
- Splitter Included in Box



### HGAL

#### Alcor Gaming Headset

- 3D stereo sound
- P3 connection
- Rainbow lighting
- Splitter Included in box
- Mesh fabric ear pads
- Cable volume control
- Multiplatform



### HGMZ

#### Mizar 7.1 Gaming Headset

- 7.1 Surround Sound
- USB connection
- Mesh Fabric Ear Pads
- Headband Volume Control
- RGB lighting
- Nylon Cable

ALCOR GAMING HEADSET

GETR  
INTO THE  
GAME!



Immersive 3D sound. Hear every step of your enemy, and stay one move ahead.



PADDED  
HEADBAND

OMNIDIRECTIONAL  
MICROPHONE

BREATHABLE FABRIC  
EAR CUSHIONS

1.8M CABLE WITH  
VOLUME CONTROL



# GAMING KEYBOARDS

The perfect round starts here



Anti-ghosting



Tactile feedback



Ergonomic design



Quality



Accuracy



Premium materials







Plug and Play



## TGHD





### Hadar Gaming Keyboard

-  Shield membrane
-  Anti-ghosting feature
-  Cleaning brush
-  Multimedia keys
-  Light-up gamer keys



## TGLH

### Lesath Gaming Keyboard

-  Shield membrane
-  Anti-ghosting feature
-  Rainbow lighting
-  Door hanger
-  Cleaning brush



## TGCT

### Centauri Mini Gaming Keyboard

-  Compact size - 60%
-  Shield membrane
-  Anti-ghosting feature
-  Smart phone holder
-  Rainbow lighting
-  Cleaning brush



# GAMING MOUSES

Accuracy with every move



Accuracy



Comfort



Ergonomics



Quality



Premium materials







Plug and play





### MGDW









#### Dragon War Gaming Mouse

-  Rainbow lighting
-  Durable switches - 10M clicks
-  Adjustable resolution - up to 2400DPI
-  Lightweight design
-  Rubberized cable



### MGCS

#### Ceres Hyperlight Gaming Mouse









-  RGB lighting
-  Adjustable resolution - 7200DPI
-  Paracord cable
-  Huano switches
-  Software included
-  Ultralight design
-  Ultraglide UPE feet
-  Compatible with most commonly-used mouse grips



### MGCSPRO

#### Ceres Pro Hyperlight Gaming Mouse

NEW RELEASE

-  RGB lighting
-  Adjustable resolution - 12400DPI
-  Paracord cable
-  Huano 20M switches
-  Software included
-  Ultralight design
-  Ultraglide UPE feet
-  Compatible with most commonly-used mouse grips



MPMXXL



# GAMING MOUSEPADS

Perfect design for every gaming style



Perfect response



Sweat resistant



Seamed Edges



Non-slip base



Design



Premium materials



Versatile use



**MPMM**  
Medium  
40x30cm





**MPML**  
Large  
45x40cm





**MPMXL**  
90x40cm

**MPMM / MPML / MPMXL**  
Merak Gaming Mousepad

NEW RELEASE

-  Speed surface
-  Seamed edges
-  Non-slip base

-  Sweatproof surface
-  Matching pad/wallpaper design



# GAMING KITS

Everything you need to take your gaming experience to the next level



Accuracy



Comfort



Ergonomics



Quality



Design



Premum materials







Plug and play



## CGCS41

Canopus 4 In 1 Gamer Combo - Green

-  Headset with immersive audio
-  High-speed mousepad with gamer print
-  High precision mouse
-  Ultra resistant materials
-  Gamer keyboard with rainbow lighting



**COMBO CGS41**  
Keyboard



**COMBO CGS41**  
Headset



**COMBO CGS41**  
Mousepad







**COMBO CGS41**  
Mouse



## CGCS41R

Canopus 4 In 1 Gamer Combo - Red

NEW RELEASE

- 
Headset with immersive audio
- 
High precision mouse
- 
Gamer keyboard with rainbow lighting
- 
High-speed mousepad with gamer print
- 
Ultra resistant materials



**COMBO CGCS41R**  
Keyboard



**COMBO CGCS41R**  
Headset



**COMBO CGCS41R**  
Mousepad



**COMBO CGCS41R**  
Mouse



CONFORT



ERGONOMICS



PREMIUM MATERIAL

# STEP INTO THE GAME WITH *THE ULTIMATE SETUP.*

A personalized setup doesn't just level up your performance—it transforms every game into an immersive experience.

With precision-driven solutions for ultimate comfort, the ELG Gaming line has everything you need to power up your gameplay..



## PRODUCTS IN THIS IMAGE

- MOUSEPAD MPXML
- CHAIR CH05BKWH
- LAMP SHLL100
- MOUSE MGCSPRO
- MOUNT F80SKIN-W
- LED STRIP SHLL200



# CHECKOUT SOLUTIONS

## Express Line



Compact packaging,  
ideal for quick points of sale



Anatel homologation  
certificate



3-year warranty



Short-circuit  
protection



Overheating  
protection



Flame resistant  
material



Durability





### L810 USB-A to Lightning Connector Cable

- 2.4A/12W Cable
- Length of 1m
- High-strength PVC coated cable (high bending resistance)
- High performance charging
- Efficiency in data transmission
- High conductivity copper filaments
- Laser welded reinforced connectors
- Cable organizer included



### TCUSB USB-A to USB-C cable

- 3A / 15W Cable
- Length of 1m
- High-strength PVC coated cable (high bending resistance)
- High performance charging
- Efficiency in data transmission
- High conductivity copper filaments
- Laser welded reinforced connectors
- Cable organizer included



### EC510PT USB-A to Micro USB Cable

- 2.4A/12W Cable
- Length of 1.25m
- High-strength PVC coated cable (high bending resistance)
- High performance charging
- Efficiency in data transmission
- High conductivity copper filaments
- Laser welded reinforced connectors
- Cable organizer included



### ECAUX1 Auxiliary Stereo Cable

- 3.5mm P2xP2 connector
- High-level audio fidelity
- Extra shielding
- Aluminum ends
- Length of 1.25m

P2 audio cable



### CC2SE

#### Universal Vehicle Charger

- 2.1A Charger
- 2 USB ports
- USB-A port 1: 5V 2.1A DC
- USB-A port 2: 5V 2.1A DC
- Input: 12 - 24V DC
- Designed for Faster and Safer Charging
- LED operating indicator



### WC1AE

#### Universal Wall Charger

- 1A Charger
- Efficient and safe charging
- 110V** **220V** Automatic bivolt (110 - 220V 50/60Hz MAX 0.5A)
- USB-A port: 5V 1A DC



### WC124E





#### Universal Wall Charger

- 2.1A Charger
- 2 USB Ports
- USB-A 1: 5V 2.1A DC
- USB-A 2: 5V 2.1A DC
- High Performance rapid charging
- 110V** **220V** Automatic Bivolt (127 - 220V 50/60Hz MAX 0.5A)



**KT810WCE**  
 Universal Lightning  
 Cable and Wall Charger Kit





NEW RELEASE

-  2.1A Charger
-  USB-A port:5V 2.1A DC
-  Lightning cable 2.4A 12W 1 meter / recharge and data transmission
-  Automatic Bivolt (127 - 220V 50/60Hz MAX 0.5A)



**KTC10WCE**  
 USB Kit C Cable &  
 Universal Wall Charger + Cable







NEW RELEASE

-  2.1A Charger
-  USB-A port :5V 2.1A DC
-  USB-C cable 2.4A 12W 1 meter / recharge and data transmission
-  Automatic Bivolt (127 - 220V 50/60Hz MAX 0.5A)



**KTW124CE**  
 USB Kit C Universal  
 Wall Charger and Cable







NEW RELEASE

-  2.1A Charger
-  2 USB ports
-  USB-A :5V 2.1A DC
-  USB-C: 5V 2.1A DC
-  USB-C cable 2.4A 12W 1 meter recharge and data transmission
-  High conductivity materials
-  Automatic Bivolt (110 - 220V 50/60Hz MAX 0.5A)



**KTC2SE**  
 USB Kit C Universal  
 Vehicle Charger and Cable







NEW RELEASE

-  2.1A Charger
-  2 USB ports
-  USB-A 1: 5V 2.1A DC
-  USB-A 2: 5V 2.1A DC
-  Input: 12 - 24V DC
-  USB-C cable 2.4A 12W 1 meter recharge and data transmission
-  LED operating indicator



**KTLC2SE**  
 Lightning Kit Universal  
 Vehicle Charger and Cable

NEW RELEASE







-  2.1A Charger
-  2 USB ports
-  USB-A 1: 5V 2.1A DC
-  USB-A 2: 5V 2.1A DC
-  Input: 12 - 24V DC
-  Lightning cable 2.4A 12W 1 meter recharge and data transmission
-  LED operating indicator



**KTC2STCE**  
 USB Kit C Universal  
 Vehicle Charger and Cable

Quick Charge Technology

NEW RELEASE

-  Charger 3.1A
-  2 USB ports
-  USB-C: 5V 3.1A DC
-  USB-A: 5V 3.1A DC
-  Input: 12 - 24V DC
-  USB-C cable 2.4A 12W 1 meter recharge and data transmission
-  LED operating indicator.

# VISIBILITY AND ORGANIZATION

Boost your sales with ELG displays.

Unleash the full potential of ELG products with displays that blend organization and creative design.

We offer the perfect solutions for retailers looking to highlight our products and create an engaging shopping experience.

Drive your sales with eye-catching displays that optimize your store's space and captivate customers.





# POS DISPLAYS

Enhance your visibility with a well-organized space



**TR\_EF Digital**  
SHFB701 Lock  
Connect Display

Measurements

- ↕ Height: 40 cm
- ↔ Width: 23 cm
- ↗ Depth: 20 cm



**TR\_EF Biometric**  
SHFD700 Lock  
Connect Display

Measurements

- ↕ Height: 40 cm
- ↔ Width: 23 cm
- ↗ Depth: 20 cm



**TR\_EMCC**  
Multiproduct  
Connect Display

Measurements

- ↕ Height: 72 cm
- ↔ Width: 68 cm
- ↗ Depth: 28 cm



## TR\_ERCE-W

Express Line Checkout  
Counter Display

Measurements

↕ Height: 50 cm

↔ Width: 30 cm

↗ Depth: 20 cm

📦 Capacity: 60 products



## TR\_ECCP

Multi-product Cardboard  
Connect Display

Measurements

↕ Height: 167,50 cm

↔ Width: 57,50 cm

↗ Depth: 40,50 cm





## TR\_EASP

### Smartphone Accessories Display

Measurements

↕ Height: 160 cm

↔ Width: 42 cm

↗ Depth: 21 cm

📦 Capacity: 120 products



## TR\_ETM

### MDF Totem Display Stand

Measurements

↕ Height: 160 cm

↔ Width: 62 cm

↗ Depth: 55 cm



**TR\_HZ-01**  
Acrylic Gamer  
Headset Display

Measurements

↕ Height: 25 cm

↔ Width: 12 cm

↗ Depth: 12 cm



**TR\_ZAHHAK**  
Zahhak Phone Checkout  
Counter Gamer Display

Measurements

↕ Height: 35 cm

↔ Width: 20 cm

↗ Depth: 10 cm



## TR\_EGAP

Multi-product Cardboard  
Gamer Display

Measurements

↕ Height: 150 cm

↔ Width: 60 cm

↗ Depth: 31,50 cm



## TR\_EMG

Mobile LED  
Gamer Display

Measurements

↕ Height: 138 cm

↔ Width: 100 cm

↗ Depth: 45,50 cm

**elg**  
www.elg.com.br



 @elgconnect



 @elgsuportes



 @elggaming

 55 47 3467-4299

 contato@elg.com.br

Rua Dona Francisca, 8,300 – Block E, Module 05  
Perini Business Park Cond. – ZIP 89219-600 – Joinville-SC